



# HOWO-NX SERIES VEHICLE DRIVER'S MANUAL

English version: Page 01-20 

中文版：第 21-42 页

# TABLE OF CONTENTS

1

## Introduction

1.1 Cabin Interior Overview.....	01
1.2 Instrument Panel.....	02
1.3 Detection Lamps And Alarm Lamps.....	03
1.4 Rocker Switches And Buttons.....	04

2

## Operating Introduction

2.1 Engine Start.....	06
2.2 Air Condition System.....	07
2.3 Towing Preparation(Traction).....	09
2.4 Transmission.....	10
2.5 Engage Differential Lock.....	11
2.6 Power Take-off.....	12
2.7 Fifth Wheel.....	13
2.8 Dump Truck Cargo Box.....	15

3

## Inspection Introduction

3.1 Cooling system.....	16
3.2 Engine oil.....	17
3.3 Air Dryer.....	17
3.4 Clutch System.....	18
3.5 Oil bath air filter.....	19
3.6 Other Notes.....	20

# 1. INTRODUCTION

## 1.1 CABIN INTERIOR OVERVIEW

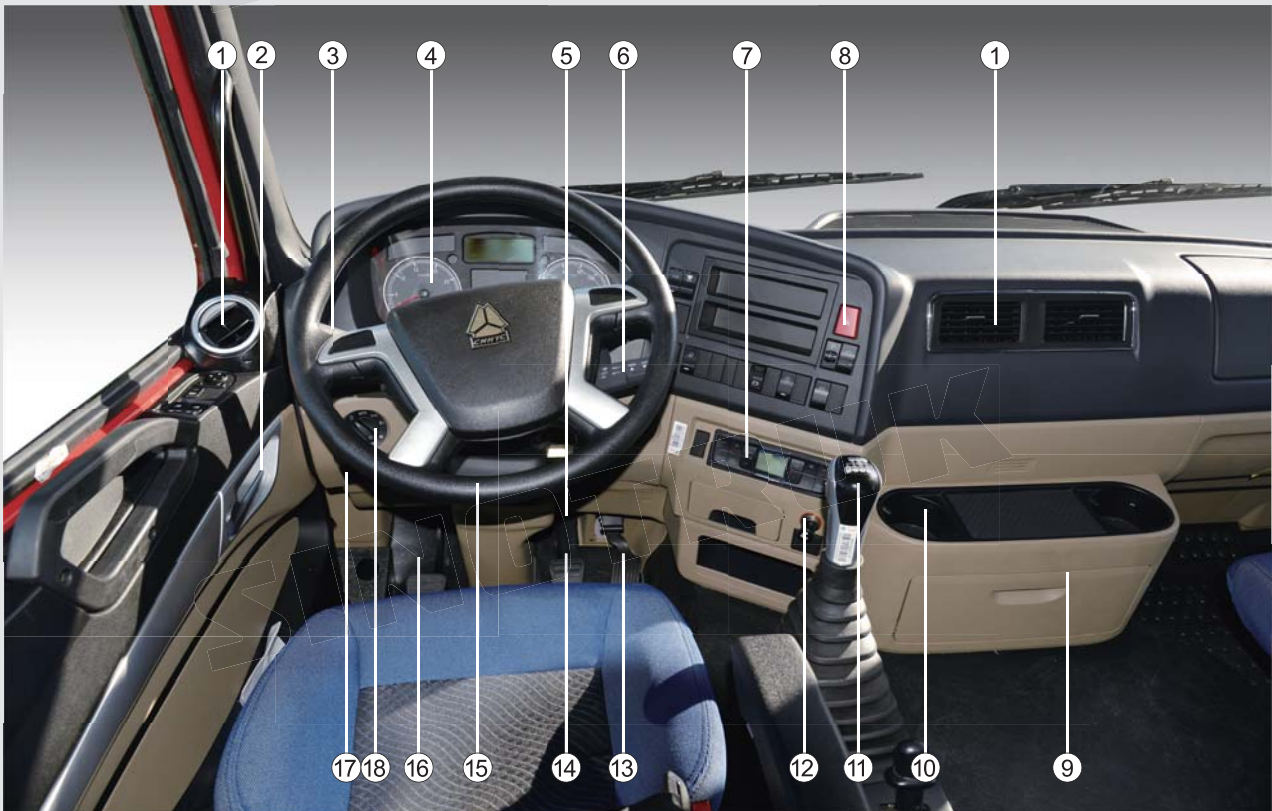

1	Ventilation opening
2	Door handle
3	Left combination switch
4	Dashboard
5	Key switch
6	Right combination switch
7	Air conditioning control panel
8	Rocker switch
9	Storage box

10	Water cup holder
11	Transmission joystick
12	24V cigarette lighter
13	Accelerator pedal
14	Brake Pedal
15	Steering wheel
16	Clutch pedal
17	Front hatch handle
18	Revolving light

## 1.2 INSTRUMENT PANEL



1	Detection and warning light panel
2	Barometer
3	Driver display
4	Fuel gauge
5	Speedometer
6	Button 1 (see "Driver display and detection light panel")

7	Turn indicator
8	Water temperature meter
9	Voltmeter
10	Button 2 (see "Driver display and detection light panel")
11	Engine tachometer



## 1.3 DETECTION LAMPS AND ALARM LAMPS

No.	Description	Signal	Color	No.	Description	Signal	Color
1	Left turn reminder		green	17	Engine general fault warning lamp		yellow
2	Right turn reminder		green	18	Low gear indicator		green
3	Engine oil pressure alarm		red、yellow	19	Main vehicle ABS indicator		yellow
4	Air pressure alarm indicator		red	20	OBD indicator (emission index)		yellow
5	Parking brake indicator		red	21	Main vehicle ASR indicator		yellow
6	Trailer left turn indicator		green	22	Coolant level indicator		red
7	Trailer right turn indicator		green	23	Inter wheel differential locking indicator		yellow
8	Safety belt warning indicator		red	24	Interaxle differential lock indicator		yellow
9	High water temperature alarm indicator		red	25	ECAS alarm		red
10	Charging indicator		red	26	Power take off		green
11	main beam indicator light		green	27	Exhaust braking		yellow
12	Front fog lamp indicator		green	28	Oil water separator alarm		yellow
13	Rear fog lamp indicator		green	29	Work light indicator		green
14	Severe alarm indicator		red、yellow	30	Trailer ABS indicator		yellow
15	Fuel alarm indicator		yellow	31	Cab unlocked warning lamp		red
16	Air filter blockage alarm indicator		yellow	32	Engine critical fault warning lamp		red

## 1.4 ROCKER SWITCHES AND BUTTONS

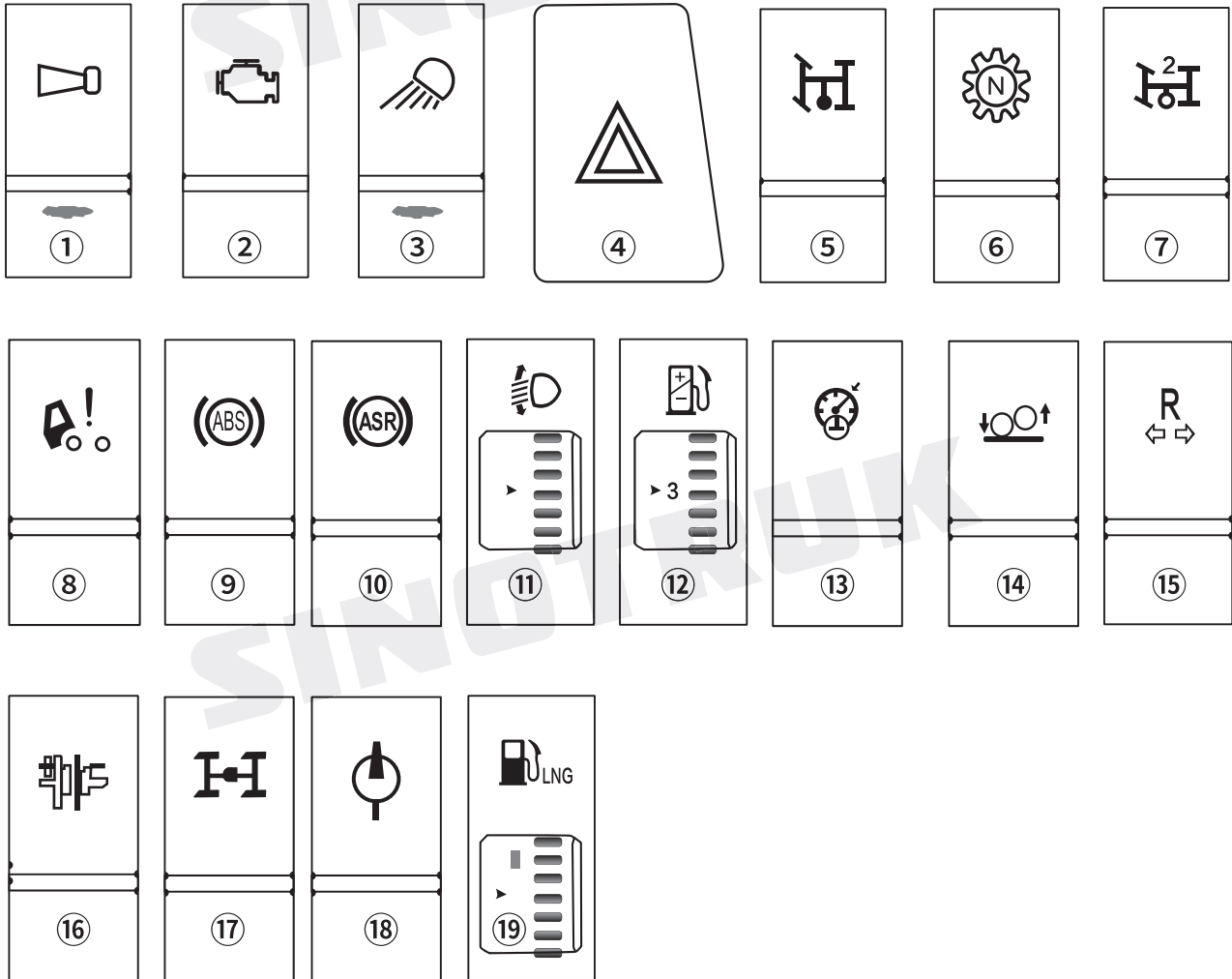

① **horn change-over switch:** when the switch is not working, press the horn button on the left combination switch, and the electric horn will sound; After pressing the switch, press the horn button on the steering wheel, and the air horn will sound.

② **engine diagnosis switch:** press the switch to read the engine fault indicator flash code on the instrument, and then look up the fault flash code table to determine the existing fault of the engine system.

③ **working light switch:** press the switch to turn on the working light behind the cab.

- ④ **emergency alarm switch:** press the switch, all the turn light will flash, and the turn indicator on the instrument will flash at the same time.
- ⑤ **power take-off switch:** press the switch and the power take-off will be combined.
- ⑥ **power take-off neutral switch:** hw13710, hw12710 and other transmissions need to press the power take-off neutral switch and power take-off switch at the same time.
- ⑦ **second power take-off switch:** when the transmission is equipped with a second power take-off, press the second power take-off switch, and the second power take-off works.
- ⑧ **cab turnover switch:** press the switch to put the lifting oil pump in the up or down state, and press the lifting button outside the cab to realize the electric lifting or down of the cab.
- ⑨ **ABS detection switch:** when the engine is started, the ABS light on the combination instrument is always on (it will also be displayed on the LCD screen), indicating that there is a fault in the system. Press the ABS detection switch to read the combination instrument. ASR indicator on the table flashes code, and the fault type is determined by checking the ABS system fault flash code table.
- ⑩ **ASR switch:** the function of ASR switch is to activate the TPM (tire pressure monitoring) function of ABS system. When the vehicle is stopped, press and hold the ASR reset switch, turn on the ignition and wait for three minutes. Seconds (until the ABS warning light goes out), release the ASR reset switch and wait for the confirmation message of TPM function initialization (ASR indicator flashes three times), indicating that the TPM function initialization is successful.
- ⑪ **headlamp beam adjustment switch:** the switch is used to adjust the beam height of the low beam lamp. The switch is of roller type, with "0", "1", "2" and "3" gears. The gear number indicated during operation turns green. The "0" gear is the initial gear and the highest position of the beam. With the increase of the gear, the height of the headlamp decreases step by step.
- ⑫ **engine multi torque switch:** adjust engine torque mode.
- ⑬ **variable speed limit adjustment switch:** press the switch to enter the vehicle speed limit mode.
- ⑭ **lifting axle switch:** press the switch to inflate the lifting axle airbag; Close the switch and deflate the lift bridge airbag.
- ⑮ **Reverse lock switch:** press the switch, the reverse lock works.
- ⑯ **Upper power switch:** press the switch to turn on the upper power.
- ⑰ **travel switch:** press the switch, and the pump truck is in the travel state.
- ⑱ **pumping switch:** press the switch, and the pump truck is in pumping state.
- ⑲ **LNG gas tank selection switch:** select the gas supply tank.

## 2. OPERATING INTRODUCTION

### 2.1 ENGINE START/STOP PROCEDURES

◆ At the first start, reset the key switch to position 2 to restart if the engine is stalled. Every start time shall not be more than 15s, the interval between two starts should not be less than 30s.

◆ It's not allowed to run the engine under cold state at high speed. Stop the engine immediately and carry out maintenance service if the oil pressure is low.

◆ Engine should keep idling speed for 3-5 minutes when being started. Load can be added after the oil pressure and oil temperature is normal (especially in cold days). Otherwise, the supercharger bearings and seal rings will be worn out due to lack of oil.

◆ Engine should run in idle speed for 3-5 minutes before the ignition is switched off. The engine can be stalled after the speed of turbocharger is reduced. Driver should be especially careful not to depress the throttle before stalling the engine. Hitting throttle will accelerate engine speed and the turbocharger will be in high speeding status. Once the engine is stalled, the oil pump stops supplying oil immediately, and the turbocharger impeller continues to run at high speed due to inertia. This action will cause the impeller shaft, bearings and seal rings to burn due to lack of oil.

◆ The turbocharger must be pre-lubricated before restarting the engine which has been stopped for a long time. This can be achieved by disassembling the oil inlet pipe of the turbocharger and pour little of clean engine oil, otherwise it will cause early wear due to lack of oil.

◆ It is strictly forbidden to cut off the circuit connection between the battery and the central control unit when the key switch and other input power with wake-up function are not turned off. Otherwise, it will not only damage the electronic control unit, line pencil and electrical components of the whole vehicle in the hardware, but also make the system data lost.

◆ When the fault is very serious, the serious fault alarm indicator "STOP" lights up, and the buzzer will keep alarming when the engine is working. At this time, just slow down, park well in a safe place, stop and check it immediately. The truck is only allowed to move forward after troubleshooting! Otherwise, it may cause loss of life and property.

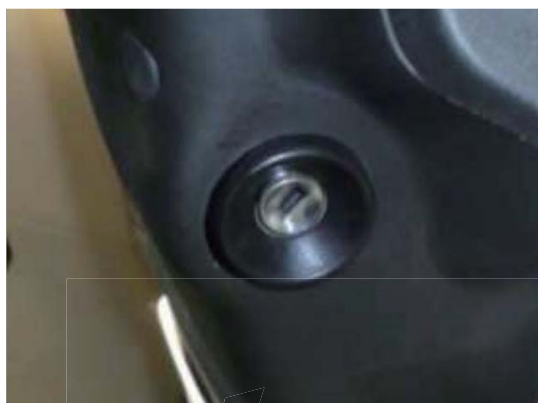



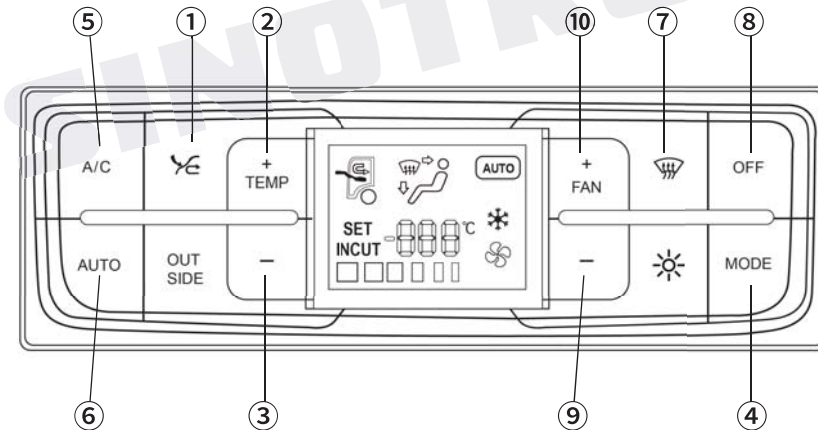

## 2.2 AIR CONDITION SYSTEM



NO.	Key	Function	Directions
1	Internal / external circulation key	Switch internal and external circulation	Each time you press this key, the system will switch between internal / external circulation states once. Press this key in auto mode to switch the internal / external air working state, and the system will not exit auto mode. When the system is set to the internal circulation state, the system will automatically switch to the external circulation state for a period of time at regular intervals, and then return to the internal circulation.
2	+TEMP Temperature increase	Press the key once to increase the set temperature by 0.5 °C	In auto mode, press these keys to change the set temperature, and the system will not exit auto mode.
3	- Temperature reduction	Press the key once to reduce the set temperature by 0.5 °C	
4	MODE MODE key	Change blowing mode	The system has 5 blowing modes, i.e. face blowing, foot blowing, foot blowing defrosting and defrosting (defrosting here only indicates the wind direction, not the opening or closing of the defrosting function). Press this key in auto mode to exit auto mode and enter face blowing mode. If the vehicle is equipped with parking air conditioner, wake up the control panel in the shutdown state, and press and hold the key for 3S to enter the parking air conditioner mode.
5	A/C A/C key	On / off air conditioning compressor	In the manual mode, the working state (suction / disconnection) of the compressor will be switched once every press. When AC is started, if the blower does not work, the system automatically sets the air volume to gear 2.
6	AUTO AUTO key	Switch to auto working mode	When the air conditioning system is turned off, press this key, and the air conditioning system will enter auto mode. When the air conditioning system is powered on, if the air conditioning system is currently in manual operation mode, press this key, and the air conditioning system will enter auto mode. In auto mode, press the temperature increase and decrease keys to change the set temperature, but the system does not exit auto mode. When the system is in auto mode and the set temperature is changed manually, press this key, the system will not exit auto mode and recalculate the set temperature according to the program. In the auto mode, press the mode, air volume increase and air volume decrease keys to exit the auto mode.
7	Defrost button	Switch to forced defrosting	Press this key in the non defrosting state to enter the defrosting mode. Press the defrosting key again to exit the defrosting mode and restore the working state before defrosting. The defrosting status automatically remembers the working mode and interface line set by the user last time. Temperature, AC, internal / external circulation and air volume adjustment do not exit the defrosting mode.
8	OFF OFF key	Off the system	When the air conditioner is turned on, press the off button to enter the off state, the display screen will close, and all actuators will close and stop working. When the air conditioner is off, press the defrost button to start the system and enter the defrost mode. When the air conditioner is in the off state, press the air volume increase button to start the operation and enter the manual mode. At the same time, the air volume is in the first gear, but the working states such as temperature, mode and internal and external circulation are set to enable the state set by the user last time. When the air conditioner is off, press the auto key to start the operation and enter the auto mode. If the off key is not used to turn off the air conditioner during the last flameout, when the ignition is again, the air conditioner will automatically enter the working mode and interface set by the user last time (manual mode, AC and air volume will not be restored; In case of auto mode, operate in auto mode).

NO.	Key	Function	Directions
9	 Air volume reduction key	Reduce air volume	Each time press the key, the air volume will be reduced by one gear to zero gear step by step. When it is reduced to gear 0, the compressor does not work and the air conditioning pattern is not displayed. In auto mode, when the air volume is changed manually, it will exit from auto mode.
10	 Air volume increase button	Increase air volume	Each time press the key, the air volume will be increased by one gear step by step to gear 4, and remain unchanged to the maximum gear. In auto mode, when the air volume is changed manually, it will exit from auto mode. The fan can be turned on only when the engine is working. mode.

## Self check and error repair function of air conditioning control system

### ◆ Self test conditions:

At the same time, press the auto key, water valve key and cycle key for 3 seconds, and then the control panel will enter the self inspection program.

### ◆ Self inspection contents:

After the automatic operation of each actuator, the fault information will be displayed.

### ◆ The actuator operates in the following order:

- First, display the full screen (that is, display all the symbols to be displayed);
- Blowing surface, internal circulation, first gear of wind speed, AC opening, water valve closing;
- Blowing face and foot, external circulation, wind speed rising from first gear to third gear, AC closing, water valve opening;
- Foot blowing, external circulation, wind speed up to the maximum gear, AC closed, water valve closed;
- Display fault code;
- Automatically exit the self-test program.

The display time of each item shall not be less than 1.5s, and the display speed shall be uniform and consistent for easy viewing Check.

### ◆ Automatic exit mode of forced self test:

After the automatic operation of each actuator, the fault information will be displayed.

- Automatically exit after the end of display;
- Press any key;
- Power on status after self check exit.

00	Normal
01	Interior temperature sensor fault (short circuit, open circuit)
02	Outside temperature sensor fault (short circuit, open circuit)
03	Evaporator temperature sensor fault (short circuit, open circuit)
04	Heating and cooling actuator failure

### ◆ Fault code display mode:

a) In the self-test state, the temperature display bit will display the fault code. If there are multiple faults, the temperature display bit will display the fault code

The code is displayed at 1.5 second interval, and the interval time of single fault code is 1.5 second

The time of two failures is 3 seconds and so on. After the display, the system will exit automatically.

b) In the fault inquiry state (press the mode key and auto key at the same time), The temperature display bit will show the fault code. In case of multiple faults, the code is displayed in cycles at the speed of 1.5 second interval

The interval time of single fault code is 1.5 seconds, the interval time of two faults is 3 seconds, and so on; Press the key to stop displaying the fault code.

## 2.3 TOWING PREPARATION (Traction)

The Propeller Shaft shall be disconnected before towing.

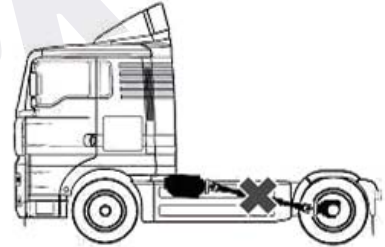

**WARNING !**

- The steering system will be damaged if the static truck is steered without hydraulic power assisted!
- The truck could be steered without hydraulic power assisted only under running state.
- When the engine stopped, due to the failure of hydraulic assist, it need more force to the steering wheel, so the towing vehicle should be slowly.
- If the air pressure of brake system is insufficient and the spring brake is activated, external compressed air can be introduced (At least 0.55MPa) or release by mechanical means. After that , the brake system of the vehicle will be disabled.

### Energy storage spring brake chamber – emergency release

◆ When the air pressure of parking brake circuit is lower than 0.55Mpa and the air pressure that acts on the cylinder diaphragm is smaller than the spring force, the spring brake will take effect. The signal of "STOP", the fault lamp ① of brake system and the parking brake lamp ② will light up simultaneously.

◆ In case of emergency, or at the service station, the energy storage chamber of the spring brake could be released by pneumatic or mechanical means.

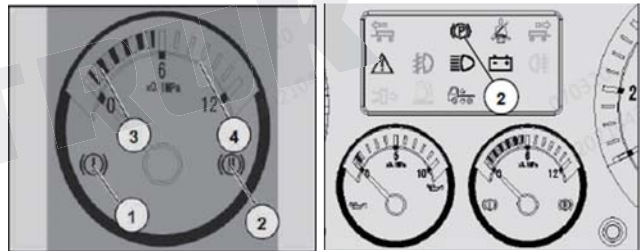

**WARNING !**

- Before releasing the energy storage spring brake chamber,make sure the truck could not be moved automatically!
- The Spring energy storage brake chamber can be temporarily released in emergency situation and maintance in service station.
- After emergency release of the spring energy storage chamber, because the lack of air pressure of circuit I and circuit II is not enough to ensure effective braking, the vehicle will cause accidents.
- The truck should not be operated before all failure warnings disappear from the dash board.

### Energy storage chamber-mechanical emergency release

◆ Diaphragm spring brake chamber: When the air pipeline which connect the brake air chamber leaks, it will cause the vehicle to brake. screwout the bolt ① to the releasing position, the brake will be released.

◆ Dual-diaphragm spring brake chamber: Open the rear cover ② of dual-diaphragm spring brake chamber and screwout the bolt ③ by hands after inserting into rear cover, then the parking brake will be released.



## 2.4 TRANSMISSION

### Transmission - without synchronizer

(HW13710(C)(L)/ HW19710(C)(L)/HW19712(C)(L)/HW20716(C)(L) .etc.)

◆ The primary transmission is not equipped with synchronizers, the gearshift is performed through movement of the sliding sleeve.

#### Shift steps:

1. When shifting gears, the clutch pedal should be fully depressed.
2. Shift from high gear to 1 and 2 gears during driving, "twice clutch operations" shall be used for shifting.
3. The vehicle should be standstill when shifting reverse gear, Otherwise the sliding sleeve is easy to be damaged.
4. The switch valve ① have high and low gears and it is located on shift handle ② .

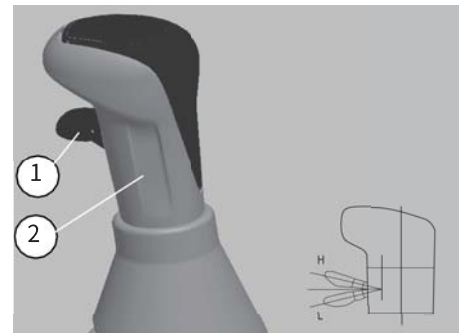

**WARNING !**

- When shifting gears, the clutch should be completely disengaged, and the gear lever should be in place.
- The switch valve shall be placed in the low gear position when the vehicle parking.
- The vehicle parking could be released until the air pressure reach the starting air pressure and move.
- You can't shift to any gear in advance Unless the current speed is within the allowable range.
- Skipping shift gear is not allowed when shifting gear from low gear position to high gear position.
- When the vehicle is going downhill, it is prohibited to change gear zone between high and low.

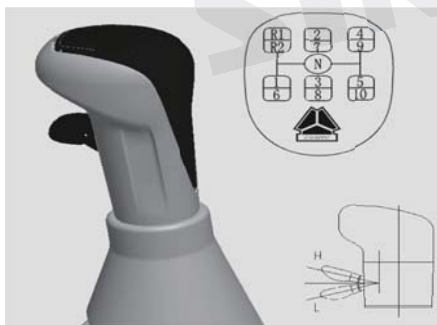

### Shift between high gear and low gear

**10 gears transmission:** When the transmission is shifted from the low zone to the high zone (and vice versa), firstly the handle valve should be placed in the H (L) position and Depress the clutch pedal to the end. Then shift to neutral gear, consciously wait for a while and then shift in 6 gear (5 gear). Skipping shift gear is not allowed and it will affect the synchronizer life. When the gearbox is in gear, if you operate the H(L) switch valve ,the high and low zone will not be changed. The high-low zone only can be changed when the transmission is in nature gear.

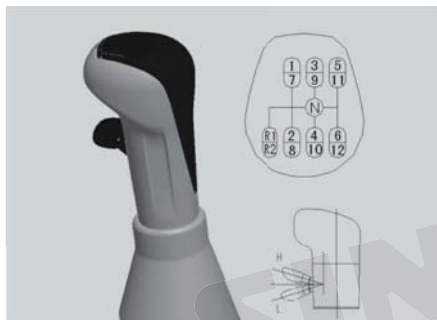

**12 gears transmission:** When the transmission is shifted from the low zone to the high zone (and vice versa), firstly the switch valve should be placed in the H (L) position and Depress the clutch pedal to the end. Then shift to neutral gear, consciously wait for a while and then shift to 7 gear (6 gear). Skipping shift gear is not allowed and it will affect the synchronizer life. When the gearbox is in gear, if you operate the H(L) switch valve ,the high and low zone will not be changed. The high-low zone only can be changed when the transmission is in nature gear.

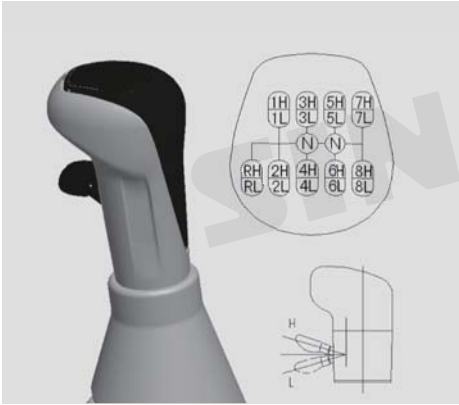

**16 gears transmission:** When the 16-speed transmission is shifted between split gears (half gears), first switch the valve which on the shift handle (as shown in the figure). The Steps to change from 1L to 1H: Firstly switch the valve from L to H position, then depress the clutch pedal to the end, release the clutch pedal, and the gear shifting is completed (The handle does not move during this process); The Steps to change from 1H to 2L: Firstly switch the valve from H to L position, then depress the clutch pedal, return the handle to neutral, and then shift handle to the 2nd gear position. After hooking up, release the clutch pedal and the shift process is finished. And so on, until the shift to 8H, the same operation for downshift. If you step on the clutch pedal first, then release it, and then switch the switch on the handle, the gear will not switch. If you step on the clutch pedal first, then release it, and then switch the switch on the handle, the gear will not switch.

## 2.5 ENGAGE DIFFERENTIAL LOCK

◆ **Operation principle of the engagement of differential lock:** Firstly engage the inter-axle differential lock and then engage the inter-wheel differential lock.

### Inter-axle differential lock

◆ **Inter-axle differential lock:** Used for locking the first and second drive axles.

◆ **Engagement of inter-axle differential lock**

1. Release the throttle pedal (deceleration).
2. Push the lower part of inter-axle differential lock switch ①, When the inter-axle differential lock engages, the inter-axle differential lock indicator lamp of instrument panel will be on.

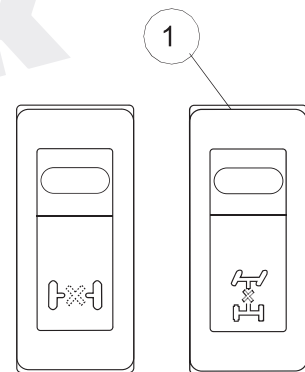

◆ **Disengage the differential lock**

1. Release the throttle pedal and depress the clutch pedal.
2. Press the upper part of the inter-axle differential switch ①, after the inter-axle differential lock is released, the inter-axle differential indicator on the dashboard will be off.



- The differential lock can only be engaged when the vehicle is stopped or when driving straight at a low speed (equivalent to a walking speed).
- When the inter-axle differential lock indicator is on, the vehicle can not turn left or right and drive at high speed.

## Differential lock between wheels

### ◆ Engagement of differential lock between wheels:

1. Engage the differential lock between shafts.
2. Release the accelerator pedal (decelerate).
3. Press the lower part of the wheel difference switch ②, the differential lock between the wheels of the rear axle is engaged, and the indicator light of the differential lock between the wheels is on.
4. Carefully step on the accelerator pedal and accelerate slowly.

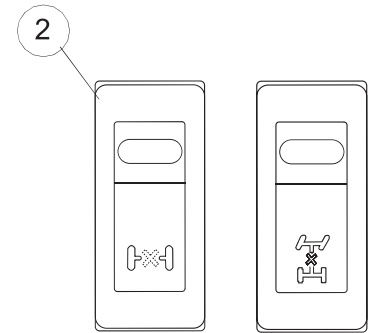

### ◆ Disengage the differential lock

1. Release the accelerator pedal and depress the clutch pedal.
2. Press the upper part of the wheel difference switch ②, when the inter-wheel differential lock is released, the inter-wheel differential indicator on the dashboard will be off.



- The differential lock can only be engaged when the vehicle is stopped or when driving straight at a low speed (equivalent to a walking speed).
- When differential lock between wheels indicator is on, the vehicle can not turn left or right and drive at high speed.

## 2.6 POWER TAKE-OFF



- Power take-off can only be used in low gear section.

### Engagement of the Power take-off

◆ Depress the clutch pedal, press the power take-off switch ①, combined with the power take-off, the indicator light ② on the instrument panel will light up, put in the low gear, and release the clutch pedal.

### Disengagement of the Power take-off

◆ Depress the clutch pedal and reset the power take-off switch ①, After about 3s, release the clutch pedal to disconnect the power take-off. At the same time, the indicator light ② on the dashboard will go off.





## 2.7 FIFTH WHEEL

### Semitrailer connection

1. Secure the semi-trailer to prevent it from sliding.
2. Lift the saddle handle ① upwards, make the handle enter the upper long hole and then pull it out until the positioning groove on the handle bar catches the saddle shell, at this time the saddle is in an open state ready to be combined.
3. Reversing docking, when the towing pin enters the saddle interface, the lock hook and wedge block will automatically lock the towing pin to complete the docking. At this time, the handle should automatically return to the position to achieve correct docking position.



**WARNING !**

- Please be sure to check whether the lock handle is correctly locked after semitrailer is connected to the tractor.

### Brake and electrical connections

#### ◆ Brake pipeline connection steps:

1. Connect the compressed air pipeline, pay attention to the pipeline that it can not be tightened, rubbed and twisted.
2. Firstly connect the brake control line connector (yellow) and then connect the brake air supply line connector (red).
3. Check its function.
4. Raise the outriggers of the semi-trailer to the driving position.



### Semitrailer Disconnection

1. Check the road conditions to prevent the semi-trailer from sliding.
2. Erect the semi-trailer outrigger (pay attention to the road load capacity) until it bears the load removed from the saddle, or raise the semi-trailer with air suspension, erect the semi-trailer outrigger, and then lower the semi-trailer until the semi-trailer is completely carried by the outrigger.
3. Before disengaging the tractor, the semi-trailer or full-trailer should strictly follow the sequence and disengage the brake air supply connector firstly (red) and then disconnect the brake control pipe (yellow), otherwise the trailer brake will be released.
4. Pull out the saddle handle ① until its positioning slot is stuck on the saddle shell, at this time the wedge block ② is disengaged from the lock hook ③. Drive the tractor forward, turn the lock hook ③, release the traction pin, and complete the disengagement action.

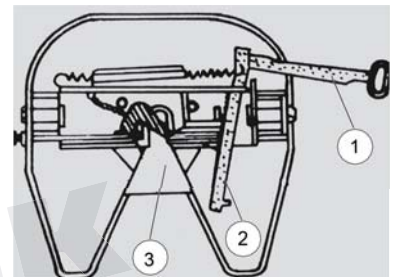

**WARNING !**

- If the trailer is not connected for a long time, the saddle handle ① should be reset.
- Be sure to disconnect the brake connectors in the correct order. Otherwise, the semi-trailer will release the brake which may cause the vehicle slip.
- After disconnecting, use the connector cover to protect the connector from contamination.

## Fifth wheel opening

◆ **As shown in the Figure:** Rotate the Locking bolt ① to the horizontal position, and at the same time push the handle ② forward, and lock the quadrilateral slot on the front side of the rectangular slot of the saddle board.

## Inspection after the coupling of trailer

1. Make sure that the locking bolt ① has returned to the state shown in the figure, and the warning hole ③ is located near the outer side of the saddle plate, at this time the saddle is locked firmly.
2. If the Locking bolt ① does not fall to the locked position, or the warning hole ③ is far from the outside of the saddle plate, check whether the saddle is locked in place.

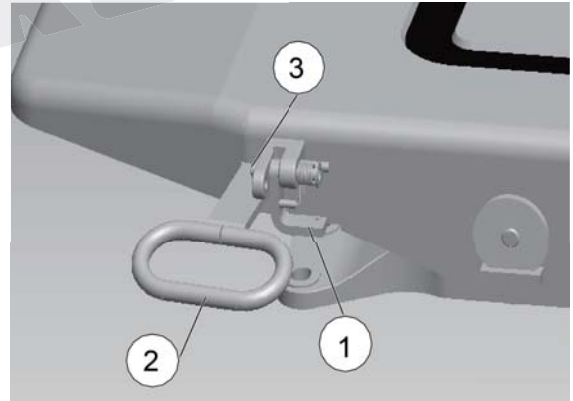

- Always operate as the requirements above.

## Maintenance of the Fifth wheel

◆ Before joining the tractor and semi-trailer, be sure to clean the upper surface of the traction seat and the lubricating oil groove ①, and make sure to fill the oil groove ① with heavy-duty grease (such as 2# lithium-based grease) and evenly coat the upper surface of the traction seat.

◆ Every 5000km, remove the grease on the upper surface of the traction seat and the lock jaw ③ and the wearing ring ②. After cleaning, use new heavy-duty grease to evenly coat the upper surface of the traction seat and the lock jaw ③, wearing ring ② and the mating surface of the traction pin.

◆ Every 5000km, adjust and check the following points.

◆ In order to compensate for the wear of the traction pin and the lock jaw ③ and prevent the locking bar from being too tight when combined so that the handle cannot be pulled out. When the tractor is combined with a semi-trailer, unscrew the adjusting bolt ⑤, and then screw it in clockwise until the adjusting bolt ⑤ is in contact with the locking bar ④, then turn the adjusting bolt ⑤ out of the counterclockwise half a turn, and then tighten the adjusting bolt on the nut.

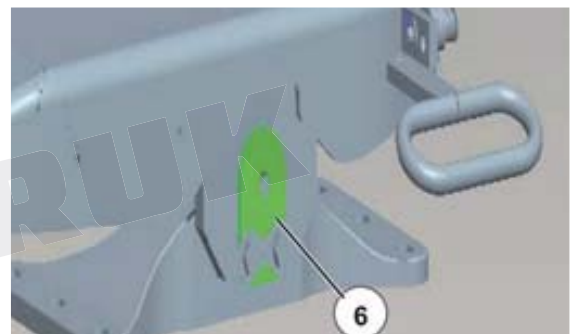
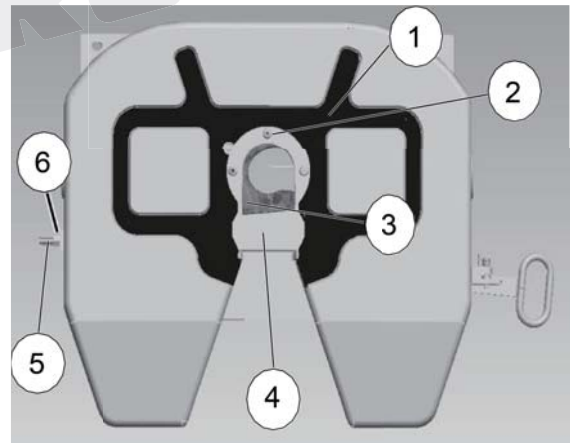





## 2.8 DUMP TRUCK CARGO BOX

### Lifting operation :

1. Open the rear door lock
2. Start the engine and wait for 5 seconds
3. Step on the clutch
4. Engage the power take-off
5. Place the air control valve ② in the "up" position
6. Release the clutch
7. When the cylinder reaches the maximum stroke (or when the limit valve is active), put the air control valve in "neutral".

**NOTE:** During the lifting process, the maximum engine speed must not exceed 1750r/min. The engine speed is too high and the oil pump is insufficiently supplied, which may cause damage to the oil cylinder and the oil pump. When approaching the maximum lift angle, the engine throttle should be gradually reduced.

### Drop operation:

1. Hydraulic lift valve and air control valve can control and adjust the descent speed of the car body
2. Step on the clutch and wait for 5 seconds
3. Disengage the power take-off
4. Disengage the gear
5. Place the air control valve in the down position
6. Release the clutch

**NOTE:** Wait for about 30 seconds after the dump body is completely lowered, and then put the air control valve in the "neutral" position. When the air control valve is in the "down" position, do not drive the vehicle to avoid causing all hydraulic oil to flow from the cylinder back to the oil tank, thereby causing "cavitation" in the hydraulic system.

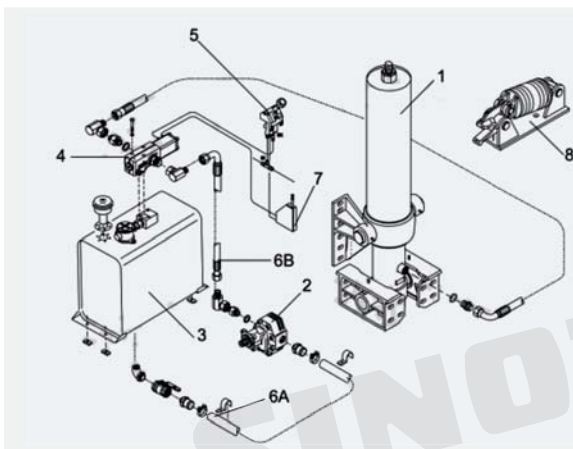

## 3. INSPECTION INTRODUCTION

### 3.1 COOLING SYSTEM: DAILY CHECK

#### Coolant level check

◆ When the vehicle is parked on a level road, observe the liquid level of the expansion tank on the rear side of the cab. It should be located between the "MAX" and "MIN" marks.



- The coolant is toxic, so avoid inhaling the body during use, storage and preparation.
- Do not open the filling cap immediately after the engine stops running to avoid scalding by the internal high temperature and pressure gas.
- If the coolant is greatly reduced during the use of the vehicle, causing the entire system to overheat, do not fill the coolant immediately at this time, or the sudden temperature change will damage the engine.
- Even if there is no anti-freezing requirement in the area where the vehicle is used (the temperature is above freezing all the year round), it is not allowed to use water instead of coolant.

#### Fill in the coolant

##### ① Filling cap    ② Pressure limiting valve

1. Turn the filling cap ① anticlockwise slowly for half a circle, release the pressure of the cooling system, and then remove the filling cap
2. Turn the warm air temperature adjustment button switch to the maximum warm air position.
3. Fill the coolant to max.
4. Put on the filling cap and tighten it.
5. run the engine for a period of time.
6. check the coolant level and replenish if necessary.

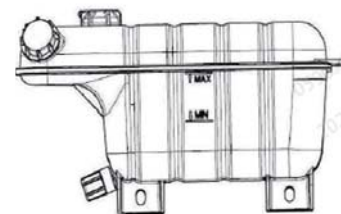
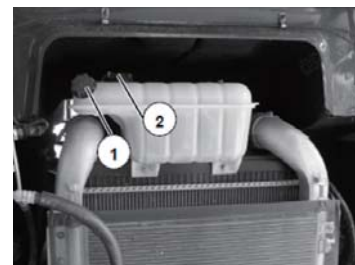

- The safety valve can keep the inside of the cooling system at a certain pressure relative to the atmosphere to increase the boiling point of the coolant. It is strictly forbidden to remove the safety valve, otherwise it will cause damage to the water pump.
- The safety valve is especially important in the plateau area. Once the pressure limiting valve is found to be damaged, it should be replaced as soon as possible.

## 3.2 ENGINE OIL: DAILY CHECK

### Engine oil level check

- ◆ Park the truck on a level road, turn off the engine for 10 minutes before checking the oil level.
- ◆ Pull out the oil dipstick ①, wipe the dipstick with a clean lint-free cloth, insert the dipstick back into the dipstick tube, pull out the dipstick again, the oil level should be between the maximum and minimum marks on the dipstick, and should not be lower than the minimum Tick mark. Check repeatedly to make sure that the oil level is low, add oil.

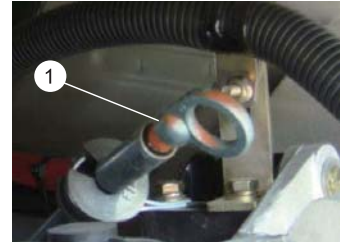

**WARNING !**

- Adding oil must not exceed the maximum scale line, too much oil will damage the engine.
- Only use engine oil certified by Sinotruk.
- Do not overfill the engine oil.

### Fill engine oil

1. Turn off the key switch
2. Open the front cover
3. Unscrew the fuel filler cap ①
4. Add oil
5. Tighten the fuel filler cap ①

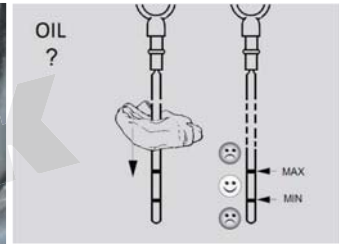
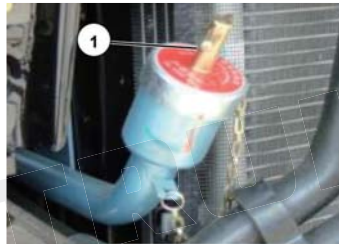

## 3.3 AIR DRYER: MONTHLY CHECK

- ◆ Check the air dryer every month to find whether it is working properly and effectively or according to the local weather conditions ,vehicle usage and driving conditions, check it more frequently. It can be checked by opening the drain valve of the air tank.



**WARNING !**

- When operating the drain valve, take care to protect your eyes and hands.
- Pay attention to check and remove the water in the air tank.

- ◆ When the vehicle stops, Press the side of the valve cone ① on the drain valve and drain the condensation.
- ◆ It is recommended to check the air reservoir furthest from the air dryer every day. If there is a mixture of oil and water at the drain valve,It indicates that the air dryer is invalid, and the granulate cartridge on the upper part of the air dryer should be replaced immediately.
- ◆ The granulate cartridge must be replaced at least every two years (recommended before winter).

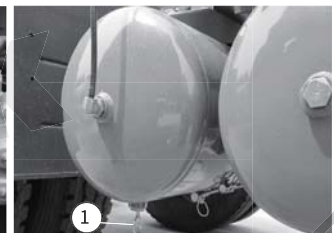

## Tire Air Refill

The tires can be inflated through the inflation connector installed on the air dryer (or air reservoir), the steps are as follows:

1. Remove the dust cap ① of the inflation connector.
2. One end of the tire inflation hose is connected to the tire valve.
3. Screw the other end of the tire inflation hose to the inflation connector on the air dryer.
4. Speed up the engine.
5. Check tire pressure and adjust as needed.



## Auxiliary air module

◆ The auxiliary air module is installed on the frame (usually located on the inner side of the longitudinal beam), unscrew the position ② or any blockage shown in the figure, and install the quick connector to get air.

## 3.4 CLUTCH SYSTEM: MONTHLY CHECK

### Check the brake fluid level:

◆ The vehicle should be parked on a level road, open the front cover of the cab, and check the brake fluid level in the clutch oil tank ⑤. The fluid level should be between the MAX and MIN marks.

◆ If necessary, unscrew the oil storage tank cap ⑥ and add DOT3/DOT4 brake fluid.

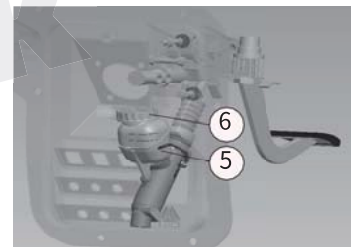

- If the oil level drops below the MIN mark, the clutch operating device will not work normally.

### Check the clutch system pipeline:

◆ Check the clutch system pipeline for air leakage.

### Check wear indicator:

◆ Check the wear indicator ② to determine whether the clutch driven disc needs to be replaced.

◆ The clutch wear indicator is located above the valve body of the clutch booster cylinder ④.

By observing the position of the indicator plate ②, you can know whether the clutch driven disc is worn to the limit, so as to replace the driven disc in time. The clutch wear indicator is used to match models with pull clutches.

◆ As the clutch driven disc wears, the gap L between the measuring rod seat ③ and the indicator plate ② will gradually increase. For HW12706T and HW12710C transmissions, when L=20mm, the driven disk needs to be replaced; for other transmissions, when L=23mm, the driven disk needs to be replaced.

◆ After the first installation of the clutch booster cylinder ④ or the replacement of the clutch driven disc, the indicator plate ② needs to be pushed along the measuring rod ① to contact with the measuring rod seat ③ to initialize. Do not move the indicator ② during normal use of the vehicle.

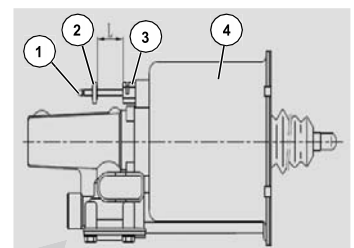

### 3.5 OIL BATH AIR FILTER



**WARNING !**

- The filter is not filled with engine oil after leave the factory !
- Before using the truck, the oil type should be same as the engine oil type !
- Fill the filter with engine oil up to 30 mm or 5L , Do not overfill !
- If the engine oil cannot flow easily when swinging the bottom case, the filter element shall be cleaned and the oil shall be replaced. Under extremely bad conditions, the filter shall be inspected on daily. In normal conditions, the filter can work 80 to 150 hours, And the filter element doesn't need to be replaced !
- The linking hook must be checked on daily to ensure that they are tightly fastened !



#### Steps of disassembling, filling and cleaning

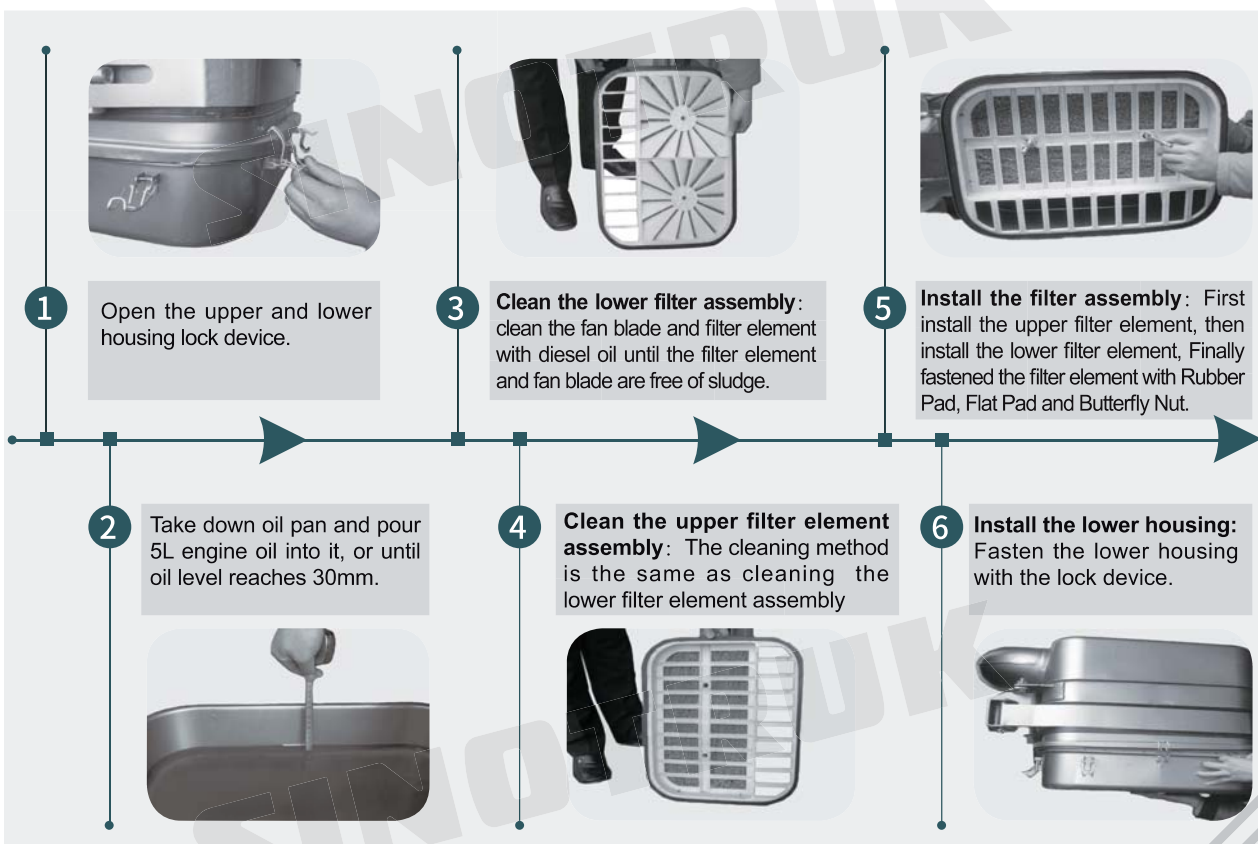

## 3.6 OTHER NOTES

- ◆ When the vehicle is going downhill, do not skid in neutral gear. When braking, use the exhaust brake to decelerate at the same time as possible. When the vehicle is heavily loaded, you can use engine brake to assist the vehicle in deceleration.
- ◆ When parking for a long time, turn off the engine to avoid accidents, turn off the main power switch and apply the parking brake.
- ◆ Unauthorized modification and installation of various equipment, especially electronics, braking, steering and other related safety systems are prohibited, otherwise it may affect the life and safety performance of the vehicle, causing accidents, fires, and damage to the vehicle. SINOTRUK will not be responsible for the consequences. It is strictly prohibited to disassemble or replace the engine ECU, otherwise the vehicle may be damaged.
- ◆ Open the front cover before tilt the cab.
- ◆ When welding work in or near the vehicle, the main power switch must be cut off and the electrical components (NANOBCU, instrument, engine ECU, ABS control unit) plugs should be unplugged.
- ◆ It is forbidden to flush the engine with water, as it will cause the engine electrical system breaking and damage the ECU.
- ◆ The cooling system uses anti-freeze and anti-rust coolant, and it is not allowed to mix different brands of coolant. If you change a different brand of coolant, you need to thoroughly clean the engine cooling system components.
- ◆ The moisture condensed in the air tank should be released in time to prevent freezing. And pay attention to check the working condition of the air dryer. Under normal circumstances, the service life of the desiccant in the dryer is two years. If water and dirt are discharged from the air tank, it indicates that the desiccant has expired, and the granulate cartridge should be replaced immediately.
- ◆ If the vehicle is parked for a long time and the temperature is low, it is best to remove the battery and put it in a warmer room. Every 5000Km, check whether the battery electrode pile and wire connection clip are loose and whether the battery working condition is normal.
- ◆ Keep good driving habits and avoid prolonged or sudden braking of the vehicle, otherwise it will affect the vehicle's life and fuel economy of the vehicle.



# HOWO-NX 车辆驾驶员手册

English version: Page 01-20

中文版：第 21-42 页 

# 目录

## 1

### 1、基础介绍

1.1 驾驶室概览 .....	23
1.2 仪表 .....	24
1.3 检测灯和报警灯 .....	25
1.4 翘板开关和按钮 .....	26

## 2

### 2、操作介绍

2.1 发动机启动 .....	28
2.2 空调系统 .....	28
2.3 牵引准备 (拖车) .....	31
2.4 变速箱 .....	32
2.5 差速锁 .....	33
2.6 取力器 .....	34
2.7 鞍座 .....	35
2.8 自卸车货箱 .....	37

## 3

### 3、检查介绍

3.1 冷却系统 .....	38
3.2 发动机机油 .....	39
3.3 空气干燥器 .....	39
3.4 离合器 .....	40
3.5 油浴式空气滤清器 .....	41
3.6 其他注意事项 .....	42



# 1. 基础介绍

## 1.1 驾驶室概览

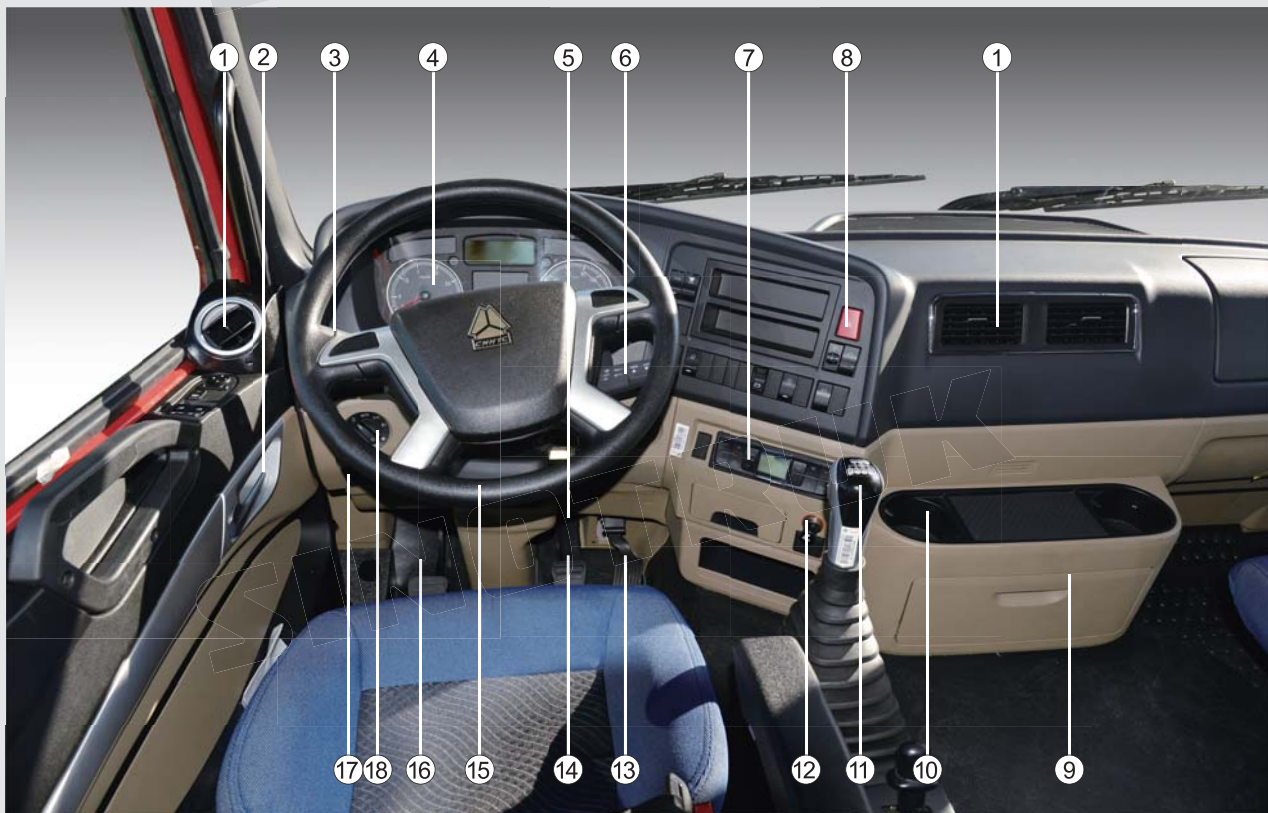

1	通风口
2	车门把手
3	左组合开关
4	仪表盘
5	钥匙开关
6	右组合开关
7	空调控制面板
8	翘板开关
9	储物盒

10	水杯架
11	变速器操纵手柄
12	24V 点烟器
13	加速踏板
14	制动踏板
15	方向盘
16	离合器踏板
17	前舱盖拉手
18	旋转灯

## 1.2 仪表板

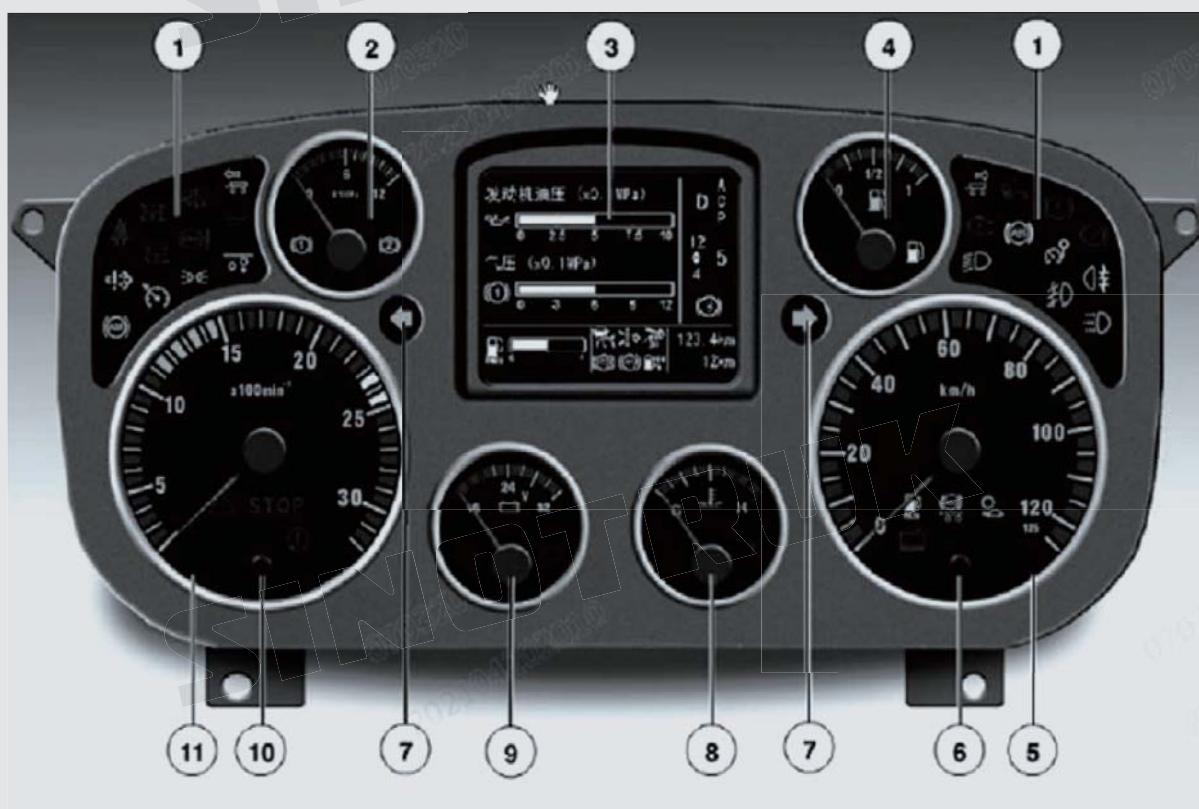

1	检测与报警灯面板
2	气压表
3	驾驶员显示屏
4	燃油表
5	车速表
6	按键 1(见“驾驶员显示屏和检测灯面板”)

7	转向指示灯
8	水温表
9	电压表
10	按键 2(见“驾驶员显示屏和检测灯面板”)
11	发动机转速表

### 1.3 检测灯和报警灯

编号	描述	符号	颜色	编号	描述	符号	颜色
1	左转向指示		绿色	17	发动机一般故障报警灯		黄色
2	右转向指示		绿色	18	低档段指示灯		绿色
3	机油压力报警		红、黄色	19	主车 ABS 指示灯		黄色
4	气压报警指示灯		红色	20	OBID 指示灯 (排放指标)		黄色
5	驻车制动指示灯		红色	21	主车 ASR 指示灯		黄色
6	挂车左转向工作指示灯		绿色	22	冷却液水位指示灯		红色
7	挂车右转向工作指示灯		绿色	23	轮间差速器锁止指示灯		黄色
8	安全带报警指示灯		红色	24	轴间差速器锁止指示灯		黄色
9	水温过高报警指示灯		红色	25	ECAS 报警		红色
10	充电指示灯		红色	26	取力器		绿色
11	远光灯指示灯		绿色	27	排气制动		黄色
12	前雾灯指示灯		绿色	28	油水分离器报警		黄色
13	后雾灯指示灯		绿色	29	工作灯指示灯		绿色
14	严重报警指示灯		红、黄色	30	挂车 ABS 指示灯		黄色
15	燃油报警指示灯		黄色	31	驾驶室未锁死报警灯		红色
16	空滤器堵塞报警指示灯		黄色	32	发动机严重故障报警灯		红色

## 1.4 翘板开关和按钮

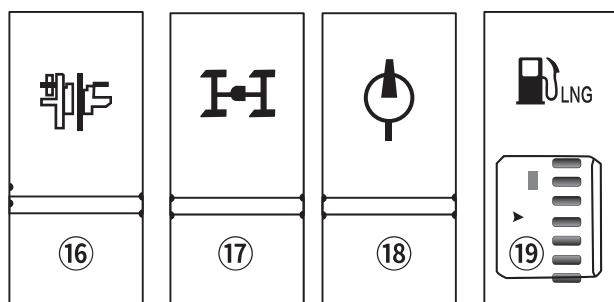
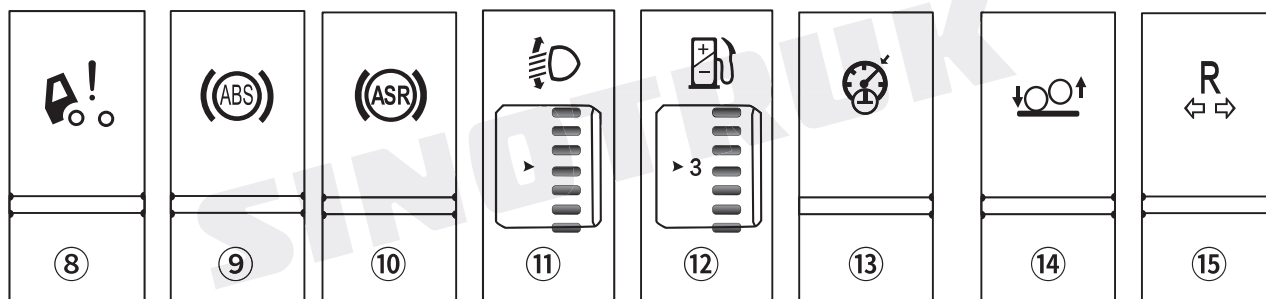
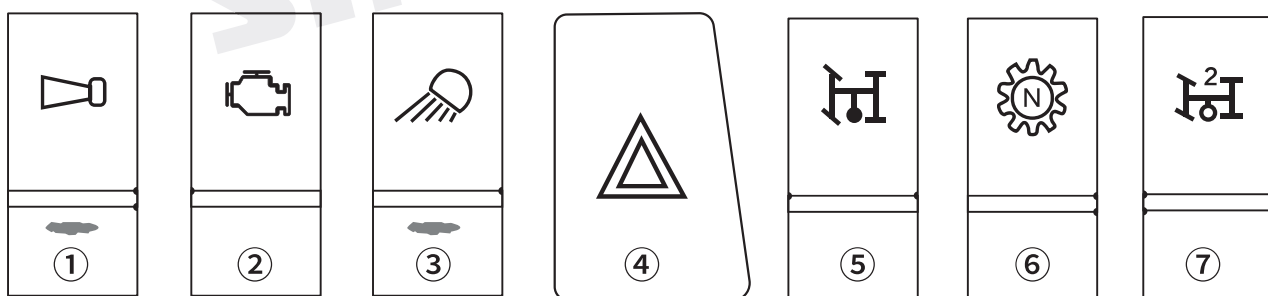

- ① **喇叭转换开关：**开关不工作时，按左组合开关上的喇叭按键，电喇叭鸣响；按下开关后，按方向盘上的喇叭按键，气喇叭鸣响。
- ② **发动机诊断开关：**按下开关，可读取仪表上的发动机故障指示灯闪码，然后查找故障闪码表，确定目前发动机系统存在的故障。
- ③ **工作灯开关：**按下开关，打开驾驶室后面的工作灯。
- ④ **危急报警开关：**按下开关，所有转向灯都会闪烁，仪表上的转向指示灯同时闪烁。
- ⑤ **取力器开关：**按下开关，取力器结合。
- ⑥ **取力器空挡开关：**HW13710、HW12710 等变速器取力，需要同时按下取力器空挡开关和取力器开关。
- ⑦ **第二取力器开关：**当变速器装有第二取力器时，按下第二取力器开关，第二取力器工作。
- ⑧ **驾驶室翻转开关：**按下开关，将举升油泵置于上升或下降状态，按下驾驶室外部的举升按钮，实现驾驶室电动举升或下降。
- ⑨ **ABS 检测开关：**当启动发动机后，组合仪表上的 ABS 灯常亮（液晶屏上也会显示），说明系统有故障，按下 ABS 检测开关，读取组合仪表上 ASR 指示灯闪码，通过查 ABS 系统故障闪码表，确定故障种类。
- ⑩ **ASR 开关：**ASR 开关的作用是激活 ABS 系统的 TPM（胎压监控）功能。车辆处于停止状态，按住 ASR 复位开关，打开点火开关，等待三秒钟（直到 ABS 警告灯熄灭），松开 ASR 复位开关，等待 TPM 功能初始化的确认信息（ASR 指示灯闪三次），说明 TPM 功能初始化成功。
- ⑪ **大灯光束调节开关：**该开关功能为调节近灯光束高度，此开关为滚轮式，设有“0”、“1”、“2”、“3”挡，工作时指示的挡位数字变成绿色，其中“0”挡为初始挡位，且为光束最高位置，随着挡位的增加，大灯高度逐级下降”。
- ⑫ **发动机多扭矩开关：**调节发动机扭矩模式。
- ⑬ **可变限速调节开关：**按下开关，进入车辆限速模式。
- ⑭ **提升轴开关：**按下开关，提升桥气囊充气；关闭开关，提升桥气囊放气。
- ⑮ **倒车锁开关：**按下开关，倒车锁工作。。
- ⑯ **上装电源开关：**按下开关，接通上装电源。
- ⑰ **行驶开关：**按下开关，拖泵车处于行驶状态。
- ⑱ **泵送开关：**按下开关，拖泵车处于泵送状态。
- ⑲ **LNG 气罐选择开关：**选择供气罐体。

## 2. 操作介绍

### 2.1 发动机起动

◆ 第一次起动时，发动机未发动，需重新将钥匙起动开关置于 2 挡，重新起动。每次起动时间不大于 15 秒，两次起动时间间隔不少于 30 秒。

◆ 发动机不得在冷车状态下高速运转！如果发动机起动后机油压力表无显示，应立即熄火检修。

◆ 发动机起动时应急速运转 3～5 分钟，不能猛轰油门，待机油压力和油温正常后方可施加负荷（特别是冷天启动），否则易使增压器轴承、密封环因缺油而早期磨损。

◆ 发动机熄火时，应急速运转 3～5 分钟，待增压器转速降低后方可熄火。特别应注意熄火前不要猛轰油门。因为猛轰油门会因发动机转速骤然提高而使增压器达到较高的转速，此时突然熄火，机油泵立即停止供油，增压器转子却因惯性还在继续高速运转，转子轴、轴承和密封环因缺油将很快烧损。

◆ 长期停机的发动机重新起动前，一定要先将增压器预润滑。可通过拆卸增压器进油管，从进油口倒入适量干净润滑油来实现，否则初次起动会因缺油而早期磨损。

◆ 严禁在未关闭钥匙起动开关或其它带有唤醒功能的输入电源时，切断电瓶和中央控制单元之间的电路连接！否则不仅可能在硬件损坏整车各系统的电控单元、线束和电子电器元器件，更有可能导致系统数据丢失，造成车辆无法使用的严重后果！

◆ 当所出现的故障性质很严重时，严重故障报警指示灯“STOP”灯亮，在发动机工作时蜂鸣器将会持续报警。此时应立即停车检查，在排除故障后才允许继续前行！否则可能会发生生命财产损失！



### 2.2 空调系统

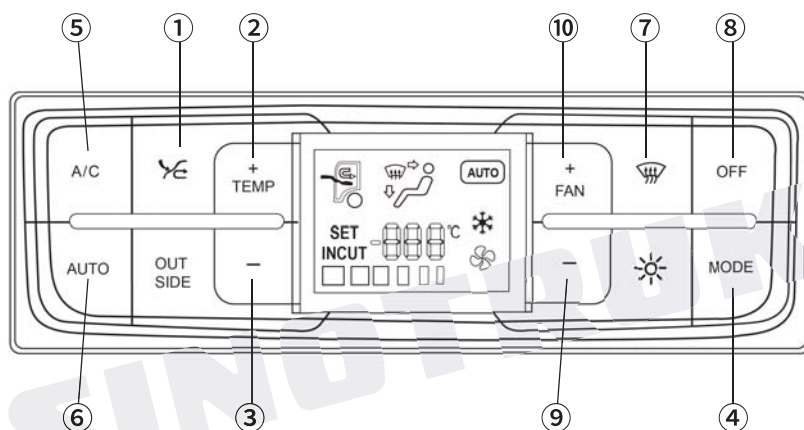

序号	按键	功能	说明
1	 内 / 外循环按键	切换内外循环	每按该键一次，系统在内 / 外循环状态间切换一次。 在 AUTO 模式下按该键，切换内 / 外气工作状态，系统不退出 AUTO 模式。 系统设定于内循环状态时，每隔一定时间，系统会自动转至外循环状态一段时间，然后再回到内循环。
2	 温度增加	按键一次增加设定温度 0.5° C	在 AUTO 模式下按这组键，改变设定温度，系统不退出 AUTO 模式。
3	 温度减小	按键一次减少设定温度 0.5° C	
4	 MODE 按键	改变吹风模式	系统共设 5 个吹风模式，即吹脸、吹脸吹脚、吹脚、吹脚除霜、除霜（此处除霜仅指出风方向，不表示除霜功能的开启或关闭）。 在 AUTO 模式下按下此键系统退出 AUTO 模式，进入吹脸模式。 如车辆选装驻车空调，停机状态下，唤醒控制面板，长按该键 3s 后进入驻车空调模式。
5	 AC 按键	开 / 关空调压缩机	手动模式下，每按一次，压缩机的工作状态（吸 / 断）切换一次。 AC 启动时如果鼓风机没有工作，则系统自动设定风量为 2 挡。
6	 AUTO 按键	切换到 AUTO 工作模式	在空调系统关机时，按下此键，空调系统进入 AUTO 模式。 在空调系统开机时，若空调系统当前为手动工作模式，按下此键，空调系统进入 AUTO 模式。 在 AUTO 模式下按温度增加、减少键，可以改变设定温度，但系统不退出 AUTO 模式。 系统已经处于 AUTO 模式且设定温度被手动改变时，按下此键，系统不退出 AUTO 模式并按程序重新计算设定温度。 在 AUTO 模式下按 MODE、风量增加、风量减少键，退出 AUTO 模式。
7	 除霜按键	切换到强制除霜	在非除霜状态下按下此键，空调进入除霜模式，再次按下除霜键退出除霜模式，并恢复除霜前的工作状态。 除霜状态自动记忆用户上次设定的工作方式和界面行。温度、AC、内 / 外循环、风量调节不退出除霜模式。
8	 OFF 按键	关闭系统	空调开机状态，按 OFF 按键，进入 OFF 状态，显示屏关闭，同时所有执行机构均关闭，停止工作。 空调在 OFF 状态时，按除霜按键系统开启工作，进入除霜模式。 空调在 OFF 状态时，按风量增加按键时，开启工作，进入手动模式，同时风量为 1 挡，但设定温度、模式、内外循环等工作状态启用用户上次设定的状态。 空调在 OFF 状态时，按 AUTO 按键，开启工作，进入 AUTO 模式。若上次熄火时没有用 OFF 键关空调，当再次点火时，空调自动进入用户上次设定的工作方式和界面工作（手动模式，AC 和风量不恢复；若为 AUTO 模式，则按 AUTO 模式运行）。
9	 减小风量按键	减小风量	每按一次，风量逐级减一挡至 0 挡。降至 0 挡时，压缩机不工作，空调图案不显示。 在 AUTO 模式下，手动改变风量时，将从 AUTO 模式退出。
10	 风量增加按键	增加风量	每按一次，风量逐级增一挡至 4 挡，到最大挡保持不变。 AUTO 模式下，手动改变风量时，将从 AUTO 模式退出。 风扇在发动机工作的前提下方可开启。

## 调空调控制系统自检及错误修补功能

### ◆ 自检条件：

同时按下 AUTO 键、水阀键、循环键 3 秒后控制面板进入自检程序。

### ◆ 自检内容：

自动运行一遍各个执行机构后显示故障信息。

### ◆ 执行机构运行按以下顺序：

- a) 先显示全屏（即显示所有需显示的符号）；
- b) 吹面、内循环、风速一档、AC 开启、水阀关闭；
- c) 吹面吹脚、外循环、风速从一档升到三挡、AC 关闭、水阀开启；
- d) 吹脚、外循环、风速升到最大挡、AC 关闭、水阀关闭；
- e) 显示故障码；
- f) 自动退出自检程序。

每项内容的显示时间不低于 1.5S，要求显示速度均匀一致，便于观察。

### 强制自检自动退出方式：

- a) 显示结束后自动退出；
- b) 按任意键；
- c) 自检退出后开机状态。

### 故障码显示方式：

a) 在自检状态下，温度显示位将显示故障代码，若为多个故障，其代码以 1.5 秒间隔的速度循环显示、单个故障码间隔时间为 1.5 秒、2 个故障时间为 3 秒依次类推。显示结束后系统自动退出。

b) 在故障查询状态下（同时按下 MODE 键、AUTO 键），温度显示位将显示故障代码，若为多个故障，其代码以 1.5 秒间隔的速度循环显示、单个故障码间隔时间为 1.5 秒、2 个故障时间为 3 秒依次类推；释放按键将停止显示故障代码。

00	正常
01	车内温度传感器故障（短路、断路）
02	车外温度传感器故障（短路、断路）
03	蒸发器温度传感器故障（短路、断路）
04	冷暖执行器故障



## 2.3 牵引准备（拖车）

牵引前，断开传动轴。

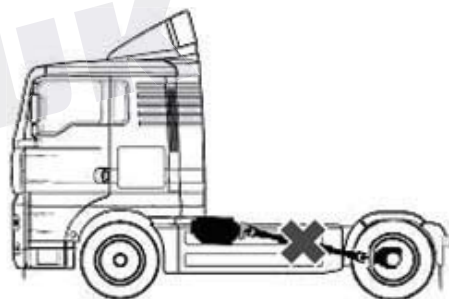

注意!

- 无液压助力时，尝试对静止车辆进行转向会导致转向系统损坏!
- 只有在车辆移动时，可以在无液压助力情况下转向。
- 如果发动机停止，由于液压助力失效，需要在方向盘上施加更大的力，应缓慢牵引车辆。
- 如果制动系统气压不足而且弹簧制动启动，可以引入外部压缩空气（至少 0.55MPa）或机械手段解除，应注意此后车辆无制动！如果气压过低（低于 0.55MPa）报警灯会亮，必须等到警报灯熄灭且显示警示信息消失之后，车辆方可起步。

### 弹簧储能制动气室—紧急解除

◆当驻车制动回路气压低于 0.55MPa 时，作用于制动气室膜片压力小于储能弹簧力，弹簧储能制动起作用。同时“STOP”、制动系统故障灯①和驻车制动灯②同时点亮。

◆紧急情况时或在维修站可以通过对弹簧储能制动气室进行气动或机械手段解除。

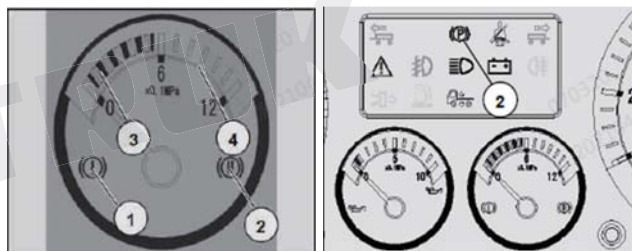

注意!

- 解除弹簧储能制动气室之前，确保汽车不能自行移动!
- 在紧急情况或服务站维修时，方可对弹簧储能制动气室紧急解除。
- 紧急解除弹簧储能气室之后，因为行车制动回路 I 和回路 II 气压不足以保证有效的制动，车辆行驶过程中容易造成事故。
- 在驻车制动信号灯熄灭之前切勿开动汽车。

### 弹簧储能制动气室—机械紧急解除

#### ◆膜片弹簧制动气室

当连接弹簧储能制动气室管路因泄漏而造成自行制动时，只要将制动气室后端的螺栓①拧出到解除位置，即可解除制动。

#### ◆双膜片弹簧制动气室

打开双膜片弹簧制动气室后端盖②，用螺栓③从后端盖插入后手动拧出，即可解除制动。

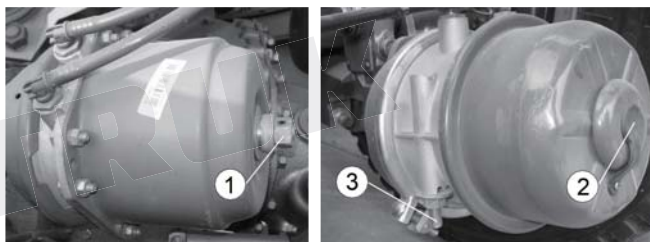

## 2.4 变速箱

### 换挡 - 不带同步器 (HW13710(C)(L)/ HW19710(C)(L)/ HW19712(C)(L)/HW20716(C)(L) 等)

◆ 该系列变速器的主箱内没有同步器，换挡是依靠移动滑套来进行换挡，步骤如下：

1. 换挡时，应将离合器踏板踩到底。
2. 车辆在行驶中由高挡换入 1 挡、2 挡时，应使用“两脚离合器法”换挡。
3. 换倒挡时应停车进行，否则易损坏啮合套。
4. 开关阀①位于换挡手柄②上，有高低两个挡位。

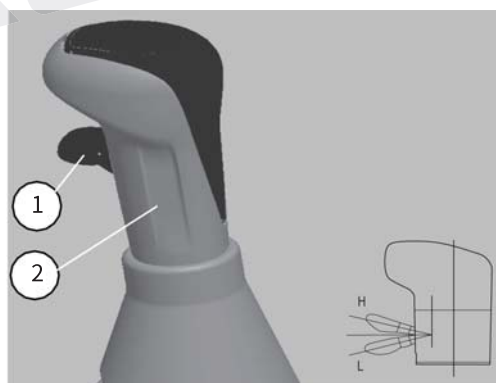

注意!

- 换挡时，离合器应彻底分离，变速杆应挂挡到位。
- 停车时，开关阀应置于低挡位置。
- 车辆应在气压上升至起步气压时，方可解除驻车制动，挂挡起步。
- 除非当前车速处于您想挂入挡允许的范围内，否则不得提前向下换到任何一挡。
- 当变速器从低挡区向高挡区（反之亦然）换挡时，不得跳挡操作。
- 车辆下坡时，禁止变换高、低挡位区。

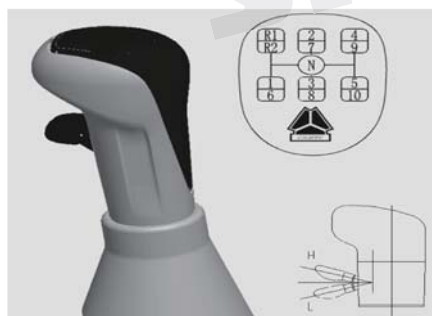

### 高低挡之间的转换

**10 挡变速器：**变速器当从低挡区向高挡区（反之亦然）换挡时，应先将手柄阀置于 H（L）位置，将离合器踏板踩到底，然后摘到空挡，有意识稍等片刻，再挂 6 挡（5 挡），不要进行跳挡操作，否则将影响副箱同步器的使用寿命。当手柄在挡位上时，进行手柄阀 H-L 切换，高低挡并不切换，只有位于空挡位置时方可进行切换。

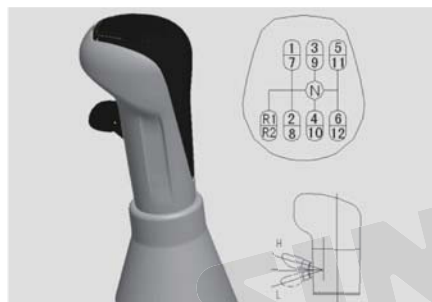

**12 挡变速器：**当从低挡区向高挡区（反之亦然）换挡时，应先将手柄阀置于 H（L）位置，将离合器踏板踩到底，然后摘到空挡，有意识稍等片刻，再挂 7 挡（6 挡），不要进行跳挡操作，否则将影响副箱同步器的使用寿命。当手柄在挡位上时，进行手柄阀 H-L 切换，高低挡并不切换，只有位于空挡位置时方可进行切换。

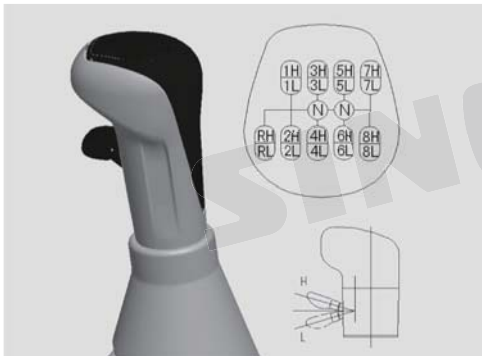

**16挡变速器：**插分挡（半挡）切换时，先切换换挡手柄上开关（如图）。如从1L换到1H的步骤：先将开关阀从L切换到H位置，然后将离合器踏板踩到底，松开离合器踏板，换挡完毕（此过程不需要手柄有动作）；从1H换到2L的步骤：先将开关阀从H切换到L位置，然后踩下离合器踏板，手柄回空挡，然后向2挡位置挂挡，挂上后，松开离合器踏板，换挡过程完毕。依次类推，直到换挡到8H，降挡同样操作。若先踩一下离合器踏板，再松开，然后切换手柄上的开关，挡位不会切换。

## 2.5 差速锁

◆差速锁啮合的操作原则：先接合轴间差速锁，再接合轮间差速锁。

### 轴间差速锁

◆轴间差速锁：用来锁止第一和第二驱动桥的轴间差速器。

◆轴间差速锁的啮合

1. 松开油门踏板（减速）。
2. 按轴间差速开关①下部，轴间差速器接合后，仪表板轴间差速锁指示灯点亮。

◆轴间差速锁的脱开

1. 松开油门踏板，踩下离合器踏板。
2. 按轴间差速开关①上部，轴间差速锁脱开后，仪表板轴间差速指示灯熄灭。

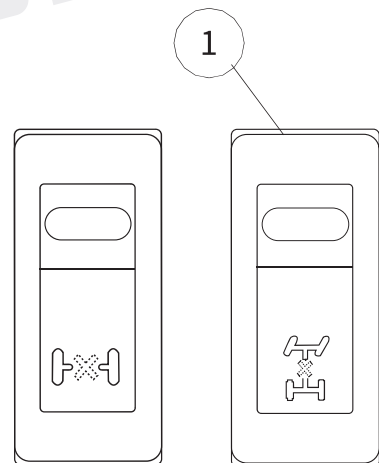

注意！

- 在车辆处于停止状态，或低速（相当于人步行的速度）下直线行驶时，才能接合差速锁。
- 当轴间差速锁指示灯点亮时，车辆不能转弯和高速行驶。

## 轮间差速锁

### ◆轮间差速锁的啮合：

1. 接合轴间差速锁（见轴间差速锁的结合）
2. 松开油门踏板（减速）
3. 按轮差开关②的下部，后桥轮间差速锁啮合，轮间差速锁指示灯点亮。
4. 小心踩油门踏板，缓慢加速。

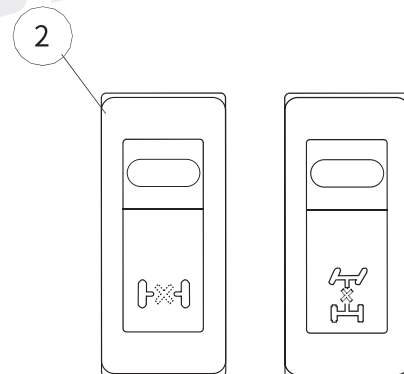

### ◆轮间差速锁的脱开：

1. 松开油门踏板，踩下离合器踏板，
2. 按轮差开关②的上部，当轮间差速锁脱开后，仪表板轮间差速指示灯熄灭。



注意！

- 只有在车辆处于停止状态，或低速（相当于人步行的速度）下直线行驶时，才能接合差速锁。
- 当轮间差速锁指示灯点亮时，车辆不能转弯和高速行驶。

## 2.6 取力器



注意！

- 只有低挡段才能使用取力器

### 取力器接合

◆踩下离合器踏板，按下取力器开关①，结合取力器，仪表板上指示灯②点亮，挂入低档位，松开离合器踏板。



### 取力器脱开

◆踩下离合器踏板，取力器开关①复位，大约 3s 后，松开离合器踏板即断开取力器。同时，仪表板上指示灯②熄灭。

## 2.7 鞍座

### 半挂车连接

1. 固定半挂车防止其滑行。
2. 将鞍座手柄①向上提起，使手柄进入上部长孔中再向外拉出，直至手柄杆上的定位槽卡住鞍座壳体，此时鞍座便处于准备结合的张口状态。
3. 倒车对接，当牵引销进入鞍座接口后，锁钩及楔座块便自动将牵引销锁住，完成对接，此时手柄应自动退回位，实现正确对接。



注意!

- 当牵引车挂接半挂车后，务必检查锁止手柄是否正确锁止。

### 制动和电气管路的连接

#### ◆ 制动管路连接步骤：

1. 连接压缩空气管路，注意管路不能被拉紧、摩擦和缠绕。
2. 首先连接制动控制管路接头（黄色），然后连接制动供气管路接头（红色）。
3. 检查其功能。
4. 将半挂车的支腿提至行车位置。



### 半挂车的脱开

1. 检查路况，防止半挂车滑行。
2. 支起半挂车支腿（注意路面负载能力），直至其承受鞍座上卸下的载荷，或使用空气悬架升高半挂车，支起半挂车支腿，然后降低半挂车，直至半挂车完全由支腿承载。
3. 半挂车或全挂车在脱开牵引车之前，应严格按顺序，先脱开制动供气管路接头（红色），然后再脱开制动控制管路（黄色），否则挂车制动会解除。
4. 将鞍座手柄①拉出，直至其定位槽卡住鞍座壳体，此时楔块②即与锁钩③脱开，向前开动牵引车，锁钩③转动，松开牵引销，完成脱开动作。

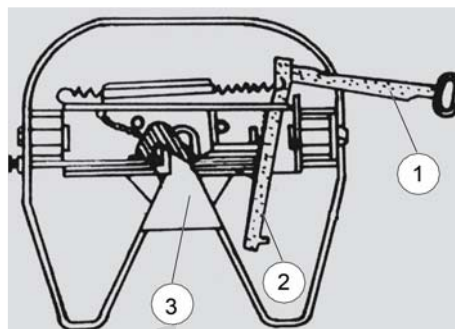

注意!

- 若较长时间不接挂车，应将鞍座手柄①复位。
- 务必按正确的顺序断开制动接头。否则半挂车将解除制动，可能导致溜车。
- 断开后用接头盖保护接头免受污染。

## 鞍座打开操作

◆ 向上旋转拉栓定位挡①至水平位置，同时向前推动手柄②，将其四边形卡槽卡在鞍座板矩形槽前侧。

## 挂上挂车后检查

1. 确保拉栓定位挡①已经回位到图示状态，并且警示孔③位于鞍座板外侧附近，此时鞍座锁合牢靠。

2. 若拉栓定位挡①未下落至锁定位置，或警示孔③离鞍座板外侧较远，应检查鞍座是否锁止到位。

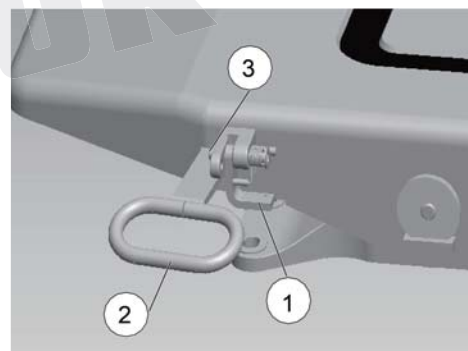

注意!

- 应按操作规范进行操作，鞍座未正确挂接会导致车辆运行事故。

## 维护保养

◆ 牵引车与半挂车接合前，务必清洁牵引座上表面及润滑油槽①，并确保使用重载润滑脂（如 2# 锂基润滑脂）注满润滑油槽①且均匀涂抹牵引座上表面。

◆ 每行驶 5000km，清除牵引座上表面及锁钩③、马蹄口②上的润滑脂，清洁后使用新重载润滑脂均匀涂抹牵引座上表面及锁钩③、马蹄口②与牵引销配合表面。

◆ 每行驶 5000km，对下述各处进行调整与检查。

◆ 为了补偿牵引销及锁钩③的磨损及防止在结合时销块过紧，使手柄无法拉出。牵引车与半挂车结合的情况下，将调整螺栓⑤旋出，再顺时针旋入，直至调整螺栓⑤与销块④接触，然后逆时针将调整螺栓⑤旋出半圈，再锁紧调整螺栓上的螺母。

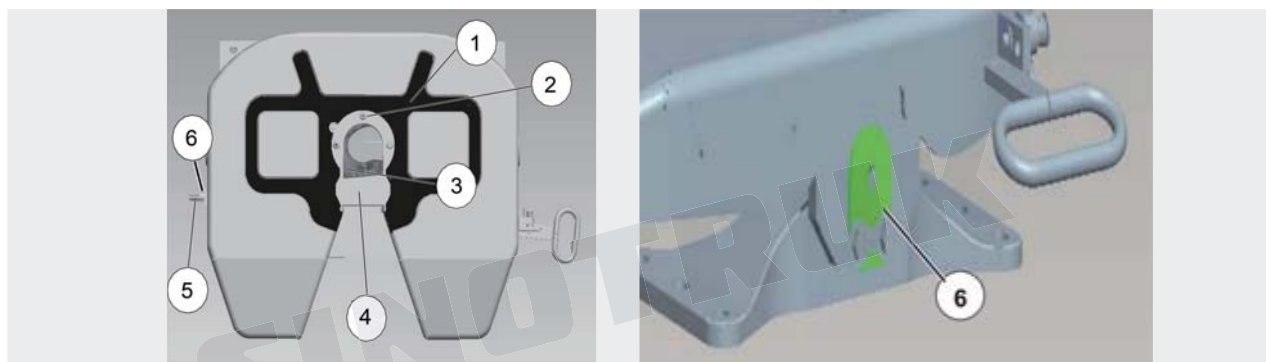

## 2.8 自卸车货箱

### 举升操作：

1. 打开后门锁
2. 启动发动机，等待 5 秒钟
3. 踩离合器
4. 接合取力器
5. 将气控阀置②于“上升”位置
6. 松开离合器
7. 当油缸达到最大行程（或限位阀起作用时），将气控阀置于“空档”。

**注意：**举升过程中，发动机最大转速不得超过 1750r/min，发动机转速过高，油泵供油不足，会引起油缸和油泵损坏。当接近最大举升角时，应逐渐减小发动机油门。

### 下降操作：

1. 液压举升阀和气控阀可以控制和调整厢体下降速度
2. 踩离合器等待 5 秒
3. 脱开取力器
4. 脱开档位
5. 将气控阀置于下降位置
6. 松开离合

**注意：**厢体完全下落后等待大约 30 秒后，再将气控阀置于“空档”位置。在气控阀处于“下降”位置时，切勿开动车辆以免引起液压油全部从油缸中流回邮箱，从而造成液压系统中产生“气蚀”现象而损害系统部件。

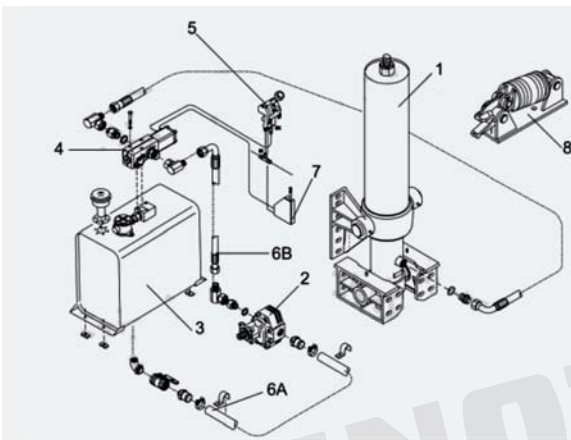

## 3. 检查介绍

### 3.1 冷却系统：每天检查

#### 冷却液液位

- ◆ 车辆应停放在水平路面上，打开前面罩。
- ◆ 观察膨胀水箱液面，冷却液液面高度应位于膨胀水箱侧面高低位标识之间。



- 冷却液有毒，在使用、保管和配制时避免吸入人体。
- 不得在发动机停止运转后立即打开加液盖，以免被内部高温压力气体烫伤。
- 车辆使用过程中如果冷却液大量减少，造成整个系统过热，此时不得立即加注冷却液，否则温度骤变会损坏发动机。
- 车辆使用地区即使没有防冻要求（气温常年在冰点以上），也不允许用水代替冷却液使用。

#### 加注冷却液 ① 加液盖 ② 限压阀

1. 将加液盖①逆时针慢慢转动半圈，释放冷却系统压力后，取下加液盖。
2. 将暖风温度调节按钮开关转到最大暖风位置。
3. 将冷却液加注至 MAX 处。
4. 盖上加液盖，将其拧紧。
5. 使发动机运行一段时间。
6. 检查冷却液位，必要时补充冷却液。

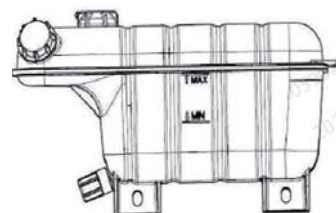
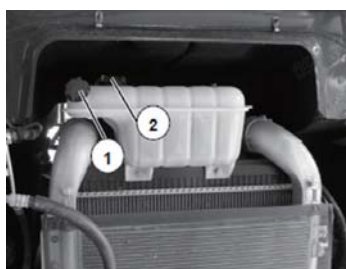

- 安全阀可使冷却系统内部保持相对于大气的一定压力，以提高冷却液的沸点，严禁拆卸安全阀，否则会对水泵造成损坏。
- 安全阀在高原地区尤其重要。限压阀一旦发现损坏，应尽快予以更换。



## 3.2 发动机机油：每天检查

### 检查发动机机油

- ◆ 汽车停放在水平路面上，关闭发动机 10 分钟后方可检查机油液位。
- ◆ 拔出机油尺①，用干净的无绒布擦拭机油尺，将机油尺插回机油尺管内，再次拔出机油尺，机油液面应位于油尺的最大和最小标记之间，不得低于最小刻度线。多次检查确定机油液位偏低时应加注机油。



**注意!**

- 加注机油不得超过最大刻度线，过多的机油会损坏发动机！
- 只能使用中国重汽认证的发动机机油。
- 机油加注不能过量！

### 加注发动机机油

1. 拧关闭钥匙开关
2. 打开前面罩
3. 拧开加油口盖①
4. 加注机油
5. 拧紧加油口盖①

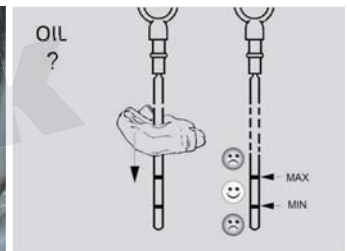
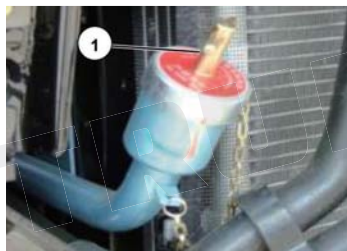

## 3.3 空气干燥器：每月检查

- ◆ 每月检查一次空气干燥器是否工作正常及有效（或根据当地气候条件、车辆使用和行车状况进行更频繁的检查）。打开贮气筒的放水阀即可检。



**注意!**

- 操作放水阀时，注意保护好眼睛和手。
- 注意检查排除制动系贮气筒中的水分。

- ◆ 汽车停止，侧向拉动贮气筒下部的自动放水阀拉环①即可排除凝聚在贮气筒中的水份。
- ◆ 建议每天检查距离空气干燥器最远的贮气筒，如果放水阀处有油水混合物排出，说明空气干燥器失效，应立即更换空气干燥器上部的干燥罐。
- ◆ 空气干燥器上部的干燥罐至少每 2 年更换一次（推荐入冬之前更换）。

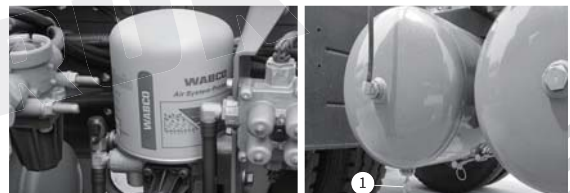

## 轮胎充气

可以通过安装在空气干燥器（或贮气筒）上的充气接头对轮胎充气，步骤如下：

1. 取下充气接头的防尘帽①。
2. 轮胎充气软管一端连接轮胎的气门嘴。
3. 将轮胎充气软管另一端拧在空气干燥器上的充气接头上。
4. 加速运转发动机。
5. 检查轮胎压力，按需调整。

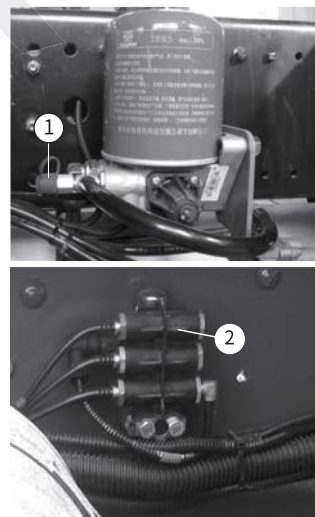

## 辅助用气模块

◆ 辅助用气模块安装于车架处（一般位于纵梁内侧），拧开图示②处或任一堵塞，配上快插接头即可取气。

## 3.4 离合器：每月检查

### 检查制动液液面高度

◆ 车辆应停放在水平路面上，打开驾驶室前面罩，检查离合器储油罐⑤中的制动液液面高度，液面应在 MAX 和 MIN 标记之间。

◆ 如有必要，拧下储油罐盖⑥，添加 DOT3/DOT4 制动液。

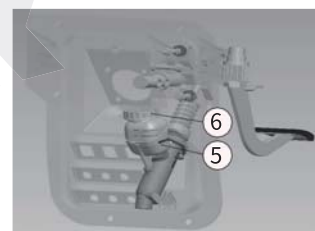

- 若油罐中的油面下降到 MIN 标记以下时，离合器操纵装置将不能正常工作。

### 检查离合器系统管路

◆ 检查离合器系统管路是否有漏气漏液情况。

### 检查磨损指示器

◆ 检查磨损指示器②，判断离合器从动盘是否需要更换。

◆ 离合器磨损指示器位于离合器助力缸④阀体上方，通过观察指示片②位置可了解离合器从动盘是否磨损到极限，以便及时更换从动盘。离合器磨损指示器用于匹配拉式离合器的车型。

◆ 随着离合器从动盘磨损，测量杆座③与指示片②间隙 L 会逐渐变大。HW12706T、HW12710C 变速器，当 L=20mm 时，需更换从动盘；其它变速器，当 L=23mm 时，需更换从动盘。

◆ 初次安装离合器助力缸④或更换离合器从动盘后，需将指示片②沿测量杆①推到与测量杆座③接触，即初始化。车辆正常使用中不要移动指示片②。

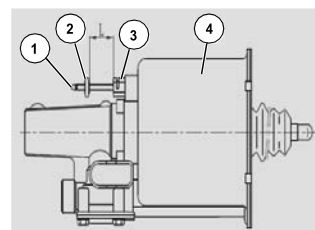

### 3.5 油浴式空气滤清器



注意!

- 新车出厂后未加注机油!
- 车辆投入运营前应加注机油，机油型号应与发动机机油相同!
- 加注机油时，油深不得超过 30mm 或加油量 5L，不得过量!
- 当晃动底壳，机油不易流动时，需清洗滤芯、更换机油。在特别恶劣的使用条件下，应每天检查。在一般情况下可连续使用 80 ~ 150 小时。滤芯可长期使用，不需要更换!
- 每天收车时需检查壳体与底壳连接螺栓或拉钩是否松动，按需紧固!

#### 拆检、加油及清洗

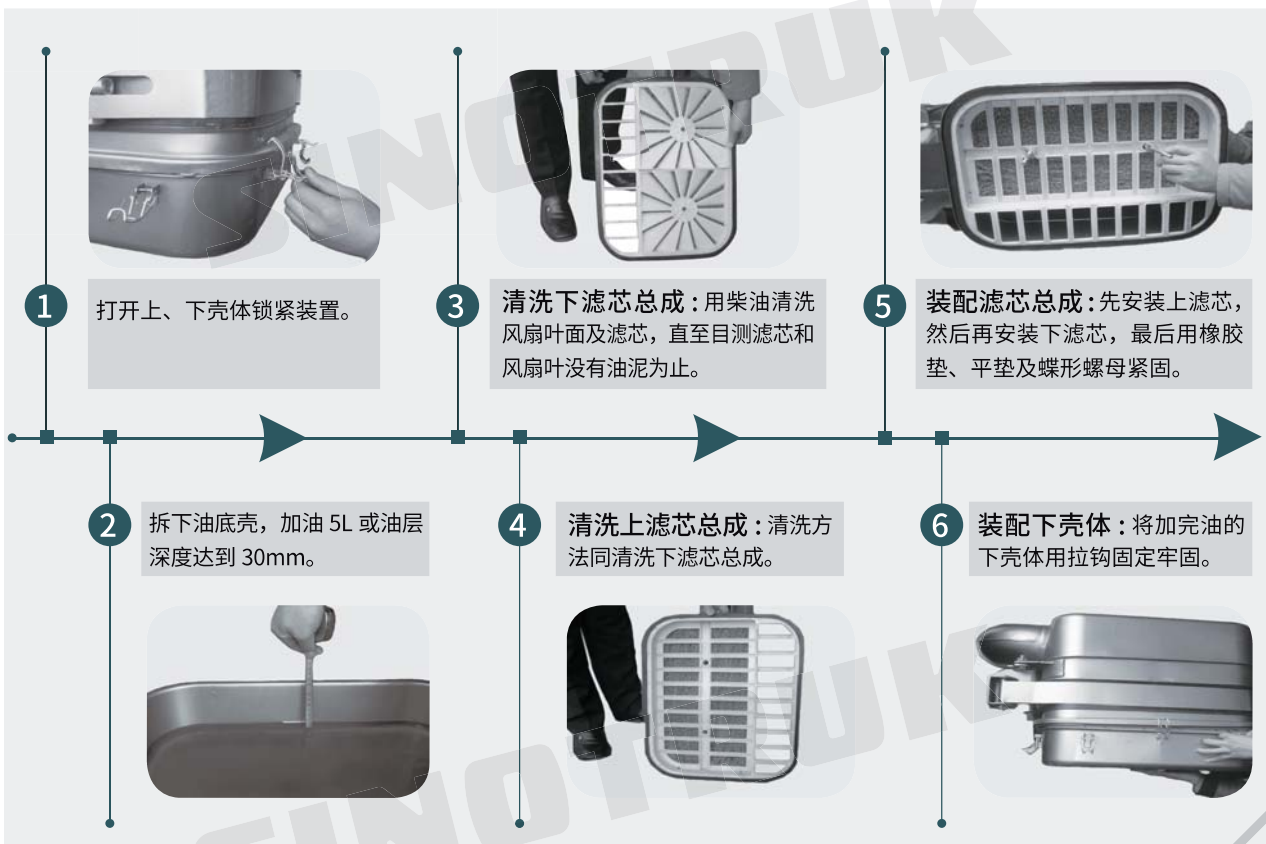

## 3.6 注意事项

- ◆当车辆下坡时，不要空挡滑行，在采取制动时尽可能同时排气制动减速，在车辆重载时也可以打开排气门制动辅助车辆减速。
- ◆当长时间停车时，关闭发动机同时为避免事故，应关闭主电源开关并采用驻车制动。
- ◆禁止未经授权的修改和安装各种设备，特别是电子、刹车、转向和其他相关安全的系统，否则它可能影响车辆的寿命和安全性能，导致事故、火灾、损坏车辆，我们将不负责后果。严格禁止拆卸或更换发动机 ECU，否则车辆可能损坏。
- ◆翻转驾驶室前应打开前面罩。
- ◆当在车辆内或车辆附近进行焊接工作时，需切断主电源开关并拔下电器元件（NANOBCU、仪表、发动机 ECU、ABS 控制单元）插接件。
- ◆禁止用水冲洗发动机，因为会导致发动机电器系统断路并损坏 ECU。
- ◆冷却系用的是防冻和防锈的冷却液，不允许不同牌号的冷却液混用。如更换不同牌号冷却液，需彻底清洗发动机冷却系统部件。
- ◆应及时放掉凝聚在储气筒中的水分，防止结冰。并注意检查空气干燥器的工作情况。正常情况下，干燥器中的干燥剂使用寿命为两年。若发现储气筒中有水污排出时，说明干燥剂已经失效，应立即更换干燥剂。
- ◆每三个月检查蓄电池电解液的液面和比重。若较长时间不使用车辆，且气温又较低时，最好将蓄电池取下并放入较温暖的室内。车辆每行驶 5000km，应检查蓄电池电极桩与导线连接夹子是否松动以及蓄电池工况是否正常。
- ◆保持好的驾驶习惯，避免长时间或突然制动车辆，否则会影响车辆的使用寿命和燃油经济性。